



DIVING

mares





REGULATORS

Mares regulators have been tested and certified in compliance with EC directive 89/686/EEC according to the EN 250: 2014 standard.

All Mares Nitrox regulators are tested in accordance with European standard EN13949.

All Mares Nitrox regulators are compatible with oxygen mixes up to 100% O2 and are equipped with a dedicated connection in conformity with European standard EN144-3.

EPIC 82X

NEW

code: 416247 INT / DIN 300

1ST STAGE

- SWIVEL TURRET
- NATURAL DFC ON ALL LP PORTS
- PRE-ORIENTED HP PORTS
- AST – FIRST STAGE DRY SYSTEM
- INT – DIN CONNECTION

2ND STAGE

- TWIN POWER SYSTEM
- ADJUSTABLE BREATHING COMFORT
- PNEUMATICALLY BALANCED SECOND STAGE
- HIGH AIR FLOW
- WIDE PIVOTING PURGE BUTTON
- COLD WATER USE
- SUPERFLEX HOSE



TECHNICAL FEATURES

Weight (g)	INT	DIN 300
First Stage	904	730
Second Stage	352	
Total Weight (including hose)	1186	1009

ACCESSORIES

	code	page
Octopus Epic	416550	12
1 st stage 82X	416248	11
DIN connector 82X	416809	14
CWD Dry Kit 82X	416859	14



Swivel Turret - Natural DFC on all LP ports



AST – First Stage Dry System



Twin Power System



Regulatable breathing comfort

LOOP 15X

code: 416241 INT / DIN 300

1ST STAGE

- DFC PORT
- PRE-ORIENTED PORTS
- INT – DIN CONNECTION
- ACT VALVE
- COMPACT SIZE

2ND STAGE

- CAN BE MOUNTED ON THE RIGHT OR THE LEFT SIDE
- FREEDOM OF MOVEMENT IN ALL DIRECTIONS
- "UNDER THE SHOULDER" HOSE POSITION
- INTEGRATED SAGITTAL VAD (S-VAD)
- TWIN EXHAUST VALVES
- OVERSIZED SILICONE PURGE BUTTON



PAT PENDING



reddot design award

TECHNICAL FEATURES

Weight (g)	INT	DIN 300
First Stage	772	598
Second Stage	199	
Total Weight (including hose)	1146	972

ACCESSORIES

	code	page
Octopus Loop	416548	12
1 st stage 15X	416237	11
DIN Connector 15X	416809	14
CWD Dry Kit 15X	416857	14

DETAILS

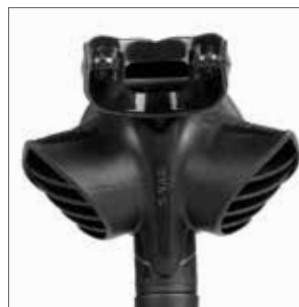

Sagittal VAD



Twin exhaust valve



Silicone purge cover



Performance-optimizing deflector

FUSION 52X

code: 416233 INT / DIN 300

1ST STAGE

- DOUBLE DFC PORTS
- PRE-ORIENTED PORTS
- INT – DIN CONNECTION
- ACT VALVE
- NCC TECHNOLOGY

2ND STAGE

- TWIN POWER SYSTEM
- VAD SYSTEM
- HIGHEST AIR FLOW
- SUPERFLEX HOSE
- WIDE PIVOTING PURGE BUTTON



reddot design award

TECHNICAL FEATURES

Weight (g)	INT	DIN 300
First Stage	687	513
Second Stage	327	
Total Weight (including hose)	1161	984

ACCESSORIES

	code	page
Octopus Fusion	416544	12
1 st stage 52X	416231	11
DIN connector 52X	416809	14
CWD Dry Kit 52X	416857	14

CARBON 52X

code: 416162 INT / DIN 300

1ST STAGE

- DOUBLE DFC PORT
- PRE-ORIENTED PORTS
- INT – DIN CONNECTION
- ACT VALVE
- NCC TECHNOLOGY

2ND STAGE

- VAD SYSTEM
- EXTREMELY LIGHTWEIGHT
- CARBON TECHNOLOGY
- SUPERFLEX HOSE
- SUPERIOR THERMAL CONDUCTIVITY



TECHNICAL FEATURES

Weight (g)	INT	DIN 300 bar
First Stage	687	513
Second Stage	197	
Total Weight (including hose)	1034	857

ACCESSORIES

	code	page
Octopus Carbon	416535	12
1 st stage 52X	416231	11
DIN connector 52X	416809	14
CWD Dry Kit 52X	416857	14

ABYSS 52X

code: 416163 INT / DIN 300

1ST STAGE

- DOUBLE DFC PORTS
- PRE-ORIENTED PORTS
- INT – DIN CONNECTION
- ACT VALVE
- NCC TECHNOLOGY

2ND STAGE

- VAD SYSTEM
- MESH GRID
- ALL-METAL TECHNOLOGY
- SUPERFLEX HOSE
- COLD WATER USE



ABYSS 52X NITROX

code: 416163 NX

1ST STAGE

- DOUBLE DFC PORTS
- PRE-ORIENTED PORTS
- NITROX CONNECTION
- ACT VALVE
- NCC TECHNOLOGY

2ND STAGE

- VAD SYSTEM
- MESH GRID
- ALL-METAL TECHNOLOGY
- SUPERFLEX HOSE
- COLD WATER USE



TECHNICAL FEATURES

Weight (g)	INT	DIN 300 bar
First Stage	687	513
Second Stage	269	
Total Weight (including hose)	1106	929

ACCESSORIES

	code	page
Octopus Abyss	416504	12
1 st stage 52X	416231	11
DIN connector 52X	416809	14
CWD Dry Kit 52X	416857	14

TECHNICAL FEATURES

Weight (g)	NX 232 bar
First Stage	554
Second Stage	269
Total Weight (including hose)	970

ACCESSORIES

	code	page
Octopus Abyss Nitrox	416504	12
1 st stage 52X	416231	11
DIN connector 52X	416809	14
CWD Dry Kit 52X	416857	14

ABYSS 22 NAVY II

code: 416171 INT / DIN 300

1ST STAGE

- HI FLOW DFC PORT
- PRE-ORIENTED PORTS
- INT – DIN CONNECTION
- CWD OIL KIT
- US NAVY APPROVED

2ND STAGE

- VAD SYSTEM
- MESH GRID
- FLUOROPOLYMER RESIN FINISH
- RUBBER HOSE
- IDEAL FOR EXTREME COLD WATER



PRESTIGE 15X

code: 416234 INT / DIN 300

1ST STAGE

- DFC PORT
- PRE-ORIENTED PORTS
- INT – DIN CONNECTION
- ACT VALVE
- COMPACT SIZE

2ND STAGE

- VAD SYSTEM WITH FLUID DYNAMIC DEFLECTOR
- COMPACT
- LIGHTWEIGHT
- SUPERFLEX HOSE
- OVERSIZED PURGE BUTTON



TECHNICAL FEATURES

Weight (g)	INT	DIN 300 bar
First Stage	850	685
Second Stage	269	
Total Weight (including hose)	1337	1172

ACCESSORIES

	code	page
Octopus Abyss Navy	416546	12
Low pressure plug (1/2")	46186207	-

TECHNICAL FEATURES

Weight (g)	INT	DIN 300 bar
First Stage	772	598
Second Stage	193	
Total Weight (including hose)	1110	936

ACCESSORIES

	code	page
Octopus Prestige	416545	13
1 st stage 15X	416237	11
DIN Connector 15X	416809	14
CWD Dry Kit 15X	416857	14

ROVER 15X

code: 416236 INT / DIN 300

1ST STAGE

- DFC PORT
- PRE-ORIENTED PORTS
- INT – DIN CONNECTION
- ACT VALVE
- COMPACT SIZE

2ND STAGE

- VAD SYSTEM WITH FLUID DYNAMIC DEFLECTOR
- MID-SIZE SECOND STAGE
- MESH GRID
- RUBBER HOSE
- OVERSIZED PURGE BUTTON



ROVER 2S

code: 416220 INT / DIN 300

1ST STAGE

- LIGHTWEIGHT, STURDY AND COMPACT
- INT – DIN CONNECTION
- PISTON CONTROL
- DEDICATED PLACE FOR RFID CHIP

2ND STAGE

- VAD SYSTEM WITH FLUID DYNAMIC DEFLECTOR
- MID-SIZE
- MESH GRID
- RUBBER HOSE
- OVERSIZED PURGE BUTTON



TECHNICAL FEATURES

Weight (g)	INT	DIN 300 bar
First Stage	772	598
Second Stage	200	
Total Weight (including hose)	1117	943

ACCESSORIES

	code	page
Octopus Rover	416505	13
1 st stage 15X	416237	11
DIN Connector 15X	416809	14
CWD Dry Kit 15X	416857	14

TECHNICAL FEATURES

Weight (g)	INT	DIN 300 bar
First Stage	608	432
Second Stage	200	
Total Weight (including hose)	987	808

ACCESSORIES

	code	page
Octopus Rover	416505	13
1 st stage 2S	416232	11
DIN Connector 2S	416809	14

1ST STAGES*

82X

NEW

code: 416248

- SWIVEL TURRET
- NATURAL DFC ON ALL LP PORTS
- PRE-ORIENTED HP PORTS
- AST – FIRST STAGE DRY SYSTEM
- INT – DIN CONNECTION



TECHNICAL FEATURES

Weight (g)	INT	DIN 300 bar
First Stage	904	730

52X

code: 416231

- DOUBLE DFC PORT
- PRE-ORIENTED PORTS
- INT – DIN CONNECTION
- ACT VALVE
- NCC TECHNOLOGY



TECHNICAL FEATURES

Weight (g)	INT	DIN 300 bar
First Stage	687	513

15X

code: 416237

- DFC PORT
- PRE-ORIENTED PORTS
- INT – DIN CONNECTION
- ACT VALVE



TECHNICAL FEATURES

Weight (g)	INT	DIN 300 bar
First Stage	772	598

2S

code: 416232

- LIGHTWEIGHT, STURDY AND COMPACT
- INT – DIN CONNECTION
- PISTON CONTROL
- DEDICATED PLACE FOR RFID CHIP



TECHNICAL FEATURES

Weight (g)	INT	DIN 300 bar
First Stage	608	432

* For use with octopuses and second stages with which it has been certified. The assembly, check and any necessary adjustments must be done by a Mares Lab Authorized Service Center.

OCTOPUS

OCTOPUS EPIC

NEW

code: 416550

- TWIN POWER SYSTEM
- ADJUSTABLE BREATHING COMFORT
- PNEUMATICALLY BALANCED SECOND STAGE
- HIGH AIR FLOW
- WIDE PIVOTING PURGE BUTTON
- SUPERFLEX HOSE



OCTOPUS CARBON

code: 416535

- VAD SYSTEM
- EXTREMELY LIGHTWEIGHT
- CARBON TECHNOLOGY
- SUPERFLEX HOSE
- SUPERIOR THERMAL CONDUCTIVITY



OCTOPUS LOOP

code: 416548

- CAN BE MOUNTED ON THE RIGHT OR THE LEFT SIDE
- FREEDOM OF MOVEMENT IN ALL DIRECTIONS
- "UNDER THE SHOULDER" HOSE POSITION
- TWIN EXHAUST VALVES
- INTEGRATED SAGITTAL VAD (S-VAD)
- OVERSIZED SILICONE PURGE BUTTON



OCTOPUS FUSION

code: 416544

- TWIN POWER SYSTEM
- VAD SYSTEM
- HIGHEST AIR FLOW
- SUPERFLEX HOSE
- WIDE PIVOTING PURGE BUTTON



OCTOPUS ABYSS NAVY

code: 416546

- VAD SYSTEM
- MESH GRID
- FLUOROPOLYMER RESIN FINISH
- RUBBER HOSE
- EXTREMELY COLD WATER USE



OCTOPUS ABYSS / ABYSS NITROX

code: 416504

- VAD SYSTEM
- MESH GRID
- ALL-METAL TECHNOLOGY
- SUPERFLEX HOSE
- COLD WATER USE



OCTOPUS

OCTOPUS PRESTIGE

code: 416545

- VAD SYSTEM WITH FLUID DYNAMIC DEFLECTOR
- COMPACT SECOND STAGE
- LIGHTWEIGHT
- SUPERFLEX HOSE
- OVERSIZED PURGE BUTTON



OCTOPUS ROVER

code: 416505

- VAD SYSTEM WITH FLUID DYNAMIC DEFLECTOR
- MID SIZED SECOND STAGE
- MESH GRID
- RUBBER HOSE
- OVERSIZED PURGE BUTTON



OCTOPUS MV

code: 416523

- VAD SYSTEM
- SMALL AND LIGHTWEIGHT
- LATERAL EXHAUST VALVE
- RUBBER HOSE
- RIGHT AND LEFT USE



AIR CONTROL*

code: 416893

- COMBINED HOSE FOR OCTOPUS AND INFLATOR
- SPECIAL ADAPTORS TO FIT ALL BCDS
- ERGONOMIC SHAPE
- ONE-HANDED USE
- PRE-ORIENTED MOUTHPIECE
- MESH GRID COVER
- EASY TO PURGE, EVEN WITH THICK GLOVES
- SUPERFLEX HOSE



* Available only in selected countries outside of the European Union

ACCESSORIES

82X-52X-15X-2S DIN CONNECTOR **NEW**

code: 416809

- FOR 200 AND 300 BAR USE
- CONICAL SINTERED FILTER



AST DRY SYSTEM **NEW**

code: 416811 INT

code: 416812 DIN

- AUTO-SEALING TECHNOLOGY
- KEEPS THE FIRST STAGE DRY
- ACTIVATED BY GAS
- CAN BE USED WITH A HIGHER PERCENTAGE OF OXYGEN
- CAN BE USED IN COLD WATER
- EASY TO INSTALL ON 82X-52X-15X AND R2 FIRST STAGES



82X CWD DRY KIT **NEW**

code: 416859

- FOR COLD WATER USE
- PROTECTS ALL MOVING PARTS
- EASY TO INSTALL



52X - 15X CWD DRY KIT

code: 416857

- FOR COLD WATER USE
- PROTECTS ALL MOVING PARTS
- EASY TO INSTALL
- PLASTIC RING FOR 15X ONLY



SWIVEL

code: 415862

- TO IMPROVE COMFORT
- 120 DEGREE ADAPTER
- EASY TO INSTALL BETWEEN HOSE AND SECOND STAGE
- 9/16" UNF



DIN/YOKE ADAPTOR

code: 415861

- FOR ALL DIN FIRST STAGES



REGULAR MOUTHPIECE KIT

code: 415335

- THE STANDARD MARES MOUTHPIECE
- STRAP INCLUDED
- FITS ON ALL MARES REGULATORS



SMALL MOUTHPIECE KIT

code: 415111

- SMALL SIZE MARES MOUTHPIECE
- STRAP INCLUDED
- FITS ON ALL MARES REGULATORS



JAX

code: 12 pcs mix **415336** (2 pcs BL/YL/BK/CL - 1 pcs GN/PK/IYL/WH)

code: 12 pcs unicolors **415347** (CL/BK/PK/BL/YL)

- CUSTOM FIT MOUTHPIECE
- VARIOUS COLOR OPTIONS
- HIGH COMFORT
- FITS ON ALL REGULATORS
- STRAP INCLUDED



CL BK PK GN BL YL IYL WH

LIQUIDSKIN MOUTHPIECE

code: **415351** (6pcs unicolors)*

- BI-SILICONE EXCLUSIVE TECHNOLOGY
- ORTHODONTICALLY OPTIMIZED
- EXTREMELY LOW JAW FATIGUE
- DIFFERENT COLOR OPTIONS WITH STRAP
- FITS ON ALL MARES REGULATORS

*Until stock lasts



CL/BL

CL/YL

JAX-S

code: 12 pcs **415354**

- SMALL SIZE CUSTOM FIT MOUTHPIECE
- HIGH COMFORT
- FITS ON ALL REGULATORS
- WHITE COLOR
- STRAP INCLUDED



LP HOSES

REGULATORS	LP HOSE WITHOUT HOSE PROTECTORS					1 ST STAGE HOSE PROTECTORS	2 ND STAGE HOSE PROTECTORS
Abyss 22 Navy	46201396	1/2"	RUBBER	BLACK	80 cm	46201249	46200846
Epic 82X	46201379	3/8"	SUPERFLEX	BLACK	75 cm		46201313
Carbon 52X- Prestige 15X - Air Control							46201473
Abyss 52X							46200846
Fusion 52X	46201477	3/8"	RUBBER	BLACK	100 cm		46201313
Loop 15 X							46201473
Rover 15X							46201406
Rover 2S	46201382	3/8"	RUBBER	BLACK	80 cm		46201473

OCTOPUS	LP HOSE WITHOUT HOSE PROTECTOR					1 ST STAGE HOSE PROTECTORS	2 ND STAGE HOSE PROTECTORS
Epic	46201381	3/8"	SUPERFLEX	YELLOW	100 cm	46201249	46201339
Fusion							46201339
Carbon							46201473
Abyss							46200846
Abyss Navy	46200846						
Loop - Prestige - Rover - MV	46201383	3/8"	RUBBER	YELLOW	100 cm	46201473	

SPECIAL LENGTH							
Regulator hose	46200984	3/8"	SUPERFLEX	BLACK	210 cm	-	-
	46200985	1/2"	SUPERFLEX	BLACK	210 cm		
	46200986	3/8"	SUPERFLEX	YELLOW	210 cm		
	46201393	3/8"	RUBBER	BLACK	210 cm		
	46201394	3/8"	RUBBER	BLACK	56 cm		

OVERVIEW PAGE REGULATOR LINE

FIRST STAGES

82X

- Balanced diaphragm design
- Swivel turret
- 2 HP 7/16" UNF ports
- 5 LP 3/8" UNF ports



52X

- Balanced diaphragm design
- 2 HP 7/16" UNF ports
- 4 LP 3/8" UNF ports



22X CWD KIT

- Balanced diaphragm design
- 2 HP 7/16" UNF ports
- 1 LP 1/2" UNF port (primary)
- 3 LP 3/8" UNF ports



15X

- Balanced diaphragm design
- 2 HP 7/16" UNF ports
- 4 LP 3/8" UNF ports



2S

- Piston design
- 1 HP 7/16" UNF port
- 4 LP 3/8" UNF ports



SECOND STAGES



Epic



Fusion



Carbon



Abyss



Abyss Navy II



Loop



Prestige



Rover

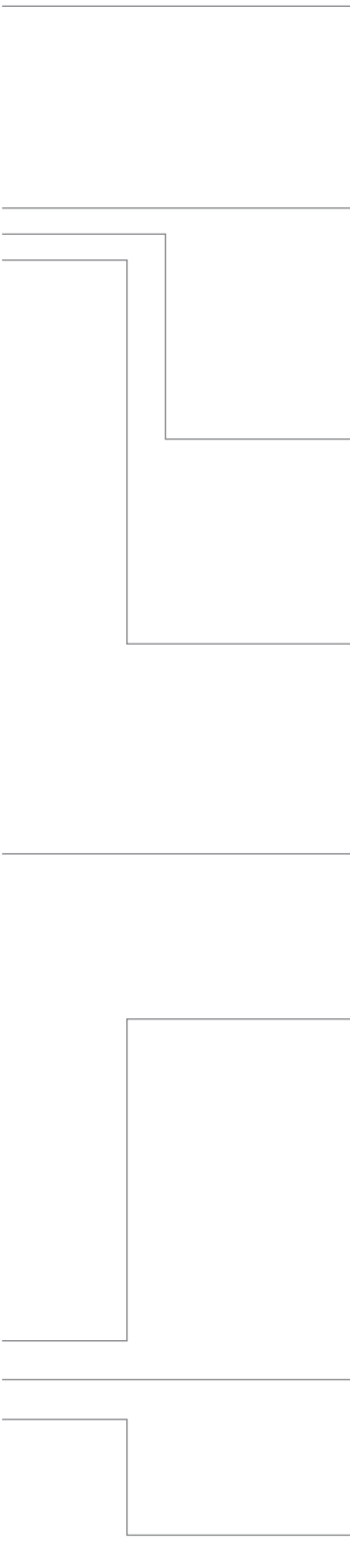

TECHNICAL SPECIFICATIONS



Regulator		Epic 82X	Loop 15X	Fusion 52X	Carbon 52X	Abyss 52X	Abyss 22 Navy II	Prestige 15X	Rover 15X	Rover 25	Air Control
Code		416247	416241	416233	416162	416163	416171	416234	416236	416220	416893
First Stage	Diaphragm	■	■	■	■	■	■	■	■		
	Piston									■	
NX (100% O ₂)						■					
ALL METAL TECHNOLOGY		■		■		■	■				
ULTRALIGHT TECHNO POLYMER			■					■	■	■	■
DFC - Dynamic Flow Control		■	■	■	■	■	■	■	■	■	
NCC - Natural Convection Channel				■	■	■					
A.C.T. VALVE - Advanced Coating Technology		■	■	■	■	■		■	■		
A.S.T. - Auto Sealing Technology		■									
SWIVEL TURRET		■									
TWIN POWER		■		■							
VAD - Vortex Assisted Design (*SVAD)		■	■ (+)	■	■	■	■	■	■	■	■
ADJUSTABLE BREATHING COMFORT		■									
PNEUMATICALLY BALANCED SYSTEM		■									
MESH GRID		■			■	■	■		■	■	■
FLUID DYNAMIC DEFLECTOR					■			■	■	■	■
SUPERFLEX HOSE		■		■	■	■		■			■
First Stage Weight (g)	INT	904	772	687	687	687	850	772	772	608	
	DIN 300 bar	730	598	513	513	513	685	598	598	432	
	NX 232 bar					554					
Second Stage Weight (g)		352	199	327	197	269	269	193	200	200	
Total Weight (g) (including hose)	INT	1186	1146	1161	1034	1106	1337	1110	1117	987	
	DIN 300 bar	1009	972	984	857	929	1172	936	943	808	
	NX 232 bar					970					



Octopus		Epic	Loop	Fusion	Carbon	Abyss	Abyss Navy	Prestige	Rover	MV
Code		416550	416548	416544	416535	416504	416546	416545	416505	416523
NX (100% O ₂)						■				
ALL METAL TECHNOLOGY		■		■		■	■			
ULTRALIGHT TECHNO POLYMER			■					■	■	■
TWIN POWER		■		■						
VAD - Vortex Assisted Design (*SVAD)		■	■ (+)	■	■	■	■	■	■	■
ADJUSTABLE BREATHING COMFORT		■								
PNEUMATICALLY BALANCED SYSTEM		■								
MESH GRID		■			■	■	■		■	
FLUID DYNAMIC DEFLECTOR									■	
SUPERFLEX HOSE		■		■	■	■		■		■
SMALL SIZE										■
Total Weight (g) (including hose)		506	374	481	354	427	427	378	385	364

QUAD AIR

17.9 m

NO DECO

3.0

DTIME

120:

1.8 bar

N2 SPEED

INSTRUMENTS

QUAD AIR

NEW

code: 414169

- MAGNIFICENTLY CLEAR DISPLAY WITH JUMBO SIZE INFORMATION
- HOSELESS TANK DATA INTEGRATION FOR UP TO THREE TRANSMITTERS
- THREE-ROW LAYOUT COMPRISES ALL RELEVANT DATA INCLUDING TANK PRESSURE
- TWO CUSTOMIZABLE FIELDS FOR ANCILLARY INFORMATION
- FOUR BUTTONS FOR INTUITIVE USER INTERFACE
- MIRRORED BUTTON FUNCTION DURING DIVE
- OPTION TO VIEW DIVE TIME INCLUDING SECONDS
- RUNAWAY DECO ALARM
- MULTIGAS CAPABLE
- DECOMPRESSION DIVE PLANNER WITH USER ADJUSTABLE SURFACE INTERVAL
- LONG BATTERY LIFE, USER REPLACEABLE



DISPLAYS

Not to scale

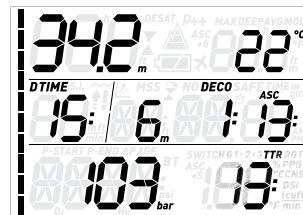

Deco Dive

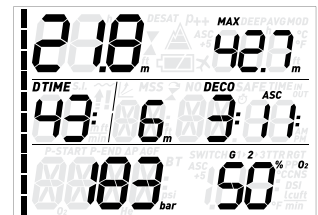

Multigas mode

TECHNICAL FEATURES

Battery	Type	CR2450
	Duration	150 dives
Nitrox		EAN from 21% to 99%

ACCESSORIES

	code	page
Bluelink Pro	414317	23
Dive Link 2 USB	414316	23
Led Tank Module	414319	26
Display Protector	415182	26

DETAILS



Led Tank Module 414319 (optional)



Bluelink Pro (optional)

QUAD

code: 414134

- MAGNIFICENTLY CLEAR DISPLAY WITH JUMBO SIZE INFORMATION
- TWO CUSTOMIZABLE FIELDS FOR ANCILLARY INFORMATION
- FOUR BUTTONS FOR INTUITIVE USER INTERFACE
- MIRRORED BUTTON FUNCTION DURING DIVE
- OPTION TO VIEW DIVE TIME INCLUDING SECONDS
- RUNAWAY DECO ALARM
- MULTIGAS CAPABLE
- DECOMPRESSION DIVE PLANNER WITH USER ADJUSTABLE SURFACE INTERVAL
- LONG BATTERY LIFE, USER REPLACEABLE



COLOR VARIATIONS



BK

WH

DISPLAYS

Not to scale

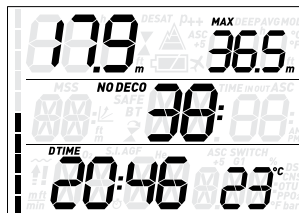

Dive time with seconds

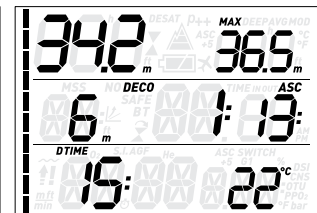

Deco Dive

TECHNICAL FEATURES

Battery	Type	CR2450
	Duration	200-300 dives
Nitrox		EAN from 21% to 99%

ACCESSORIES

	code	page
Bluelink Pro	414317	23
Dive Link 2 USB	414316	23
Display Protector	415182	26

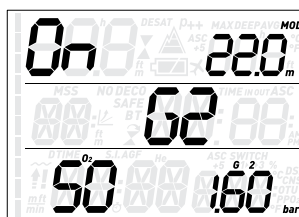

Nitrox Menu

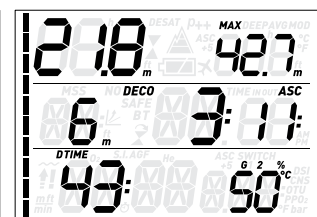

Gas Switch

ICON HD BLACK EDITION

code: 414130*

- FULL COLOR HIGH-RESOLUTION DISPLAY
- FULL TILT DIGITAL COMPASS WITH BEARING MEMORY AND STOPWATCH
- HOSELESS TANK DATA INTEGRATION FOR UP TO THREE TRANSMITTERS
- COLOR CODED TANK PRESSURE FOR AT-A-GLANCE READABILITY
- DIVE PROFILE VIEW UPDATED IN 20-SECOND INTERVALS
- BOTTOM TIMER MODE WITH RESETTABLE AVERAGE DEPTH AND STOPWATCH
- DECOMPRESSION DIVE PLANNER WITH ADDITIONAL SURFACE INTERVAL FUNCTION
- BRILLIANT LOGBOOK WITH DIVE GRAPH INCLUDING DEPTH, TEMPERATURE AND TANK PRESSURE PROFILES
- LOGBOOK CAPACITY 100 HOURS OF DIVE PROFILE AT 5-SECOND SAMPLING RATE
- ICE (IN CASE OF EMERGENCY) FUNCTION
- RECHARGEABLE BATTERY
- INCLUDES INTERFACE AND SOFTWARE FOR DOWNLOADING TO PC OR MAC
- UPGRADEABLE FIRMWARE
- NIGHT MODE FUNCTION
- MAP VIEWING FUNCTION DURING THE DIVE
- TISSUE SATURATION GRAPH WITH DETAILED INFORMATION ON DECOMPRESSION STATUS
- UNDERWATER MENU ALLOWS CERTAIN SETTINGS TO BE CHANGED ON THE MOVE
- FUTURE DECO AND RUNAWAY DECO ALARM (PROPRIETARY)
- DOWNLOADABLE MAPS (FROM PC ONLY)



DISPLAYS

Not to scale

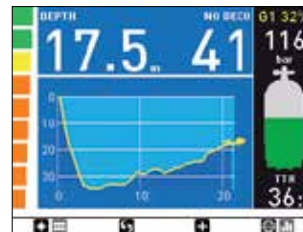

TECHNICAL FEATURES

Battery	Type	18650 Lithium Ion polymers, replaceable
	Duration	7 hours dive time/3 weeks standby/500 recharge cycles
Nitrox		EAN from 21% to 99%

ACCESSORIES

	code	page
Tank Module	414311	26

DETAILS



Air Tank Module 414311 (optional)*



USB interface included

*Until stock lasts

MATRIX

code: 414170

- COMPLETE WATCH FUNCTIONS: WAKE-UP ALARM, SECOND TIME ZONE, DATE AND CHOICE OF ANALOG OR DIGITAL TIME DISPLAY
- FULL DOT MATRIX DISPLAY
- FULL TILT DIGITAL COMPASS WITH BEARING MEMORY AND STOPWATCH
- ABILITY TO VIEW DIVE PROFILE DURING THE DIVE
- BOTTOM TIMER MODE WITH RESETTABLE AVERAGE DEPTH AND STOPWATCH
- LOGBOOK WITH DIVE GRAPH INCLUDING DEPTH PROFILE
- LOGBOOK CAPACITY 35 HOURS OF DIVE PROFILE AT 5-SECOND SAMPLING RATE
- ICE (IN CASE OF EMERGENCY) FUNCTION
- INCLUDES INTERFACE AND SOFTWARE FOR DOWNLOADING TO PC OR MAC
- RECHARGEABLE BATTERY
- UPGRADEABLE FIRMWARE



COLOR VARIATIONS



BKBK

WHWH

TECHNICAL FEATURES

Battery	Type	Custom Lithium Ion polymer
	Duration	20 hours diving/4 week standby/500 recharging cycles
Nitrox		EAN from 21% to 99%

ACCESSORIES

	code	page
Metal Strap	414811	26
Display Protector	415173	26
Strap Extension	44200966	26

SMART

code: 414129

- FREEDIVING MODE (APNEA) WITH DEDICATED ALARMS
- FULL FEATURED NITROX DIVE COMPUTER WITH TWO GAS CAPABILITY
- BOTTOM TIMER MODE WITH RESETTABLE AVERAGE DEPTH AND STOPWATCH
- LOGBOOK CAPACITY IN EXCESS OF 20 HOURS OF DIVE PROFILE AT 5-SECOND SAMPLING RATE (SCUBA) AND MEMORY FUNCTION FOR FREEDIVING
- DECOMPRESSION DIVE PLANNER WITH ADDITIONAL SURFACE INTERVAL FUNCTION
- UPGRADEABLE FIRMWARE
- COMPLETE WATCH FUNCTIONS: STOPWATCH, WAKE-UP ALARM, SECOND TIME ZONE, DATE
- USER-REPLACEABLE BATTERY



COLOR VARIATIONS



BKBK

BKGR

BKRD

BKWH

WHLM

WHLL

TECHNICAL FEATURES

Battery	Type	CR2430
	Duration	200-300 dives over a three year time span
Nitrox		EAN from 21% to 99%

ACCESSORIES

	code	page
Bluelink Pro	414317	23
Dive Link 2 USB	414316	23
Display Protector	415173	26
Strap Extension	44201190	26

PUCK PRO +

code: 414135

- SLIM DESIGN FOR A PERFECT FIT
- INTUITIVE USER INTERFACE WITH ONE-BUTTON SIMPLICITY
- LOGBOOK CAPACITY 35 HOURS OF DIVE PROFILE AT 5-SECOND SAMPLING RATE
- UPGRADEABLE FIRMWARE
- BOTTOM TIMER MODE WITH RESETTABLE AVERAGE DEPTH AND STOPWATCH
- USER-REPLACEABLE BATTERY



COLOR VARIATIONS



BKBK

BKWH

TECHNICAL FEATURES

Battery	Type	CR2450
	Duration	200-300 dives
Nitrox		EAN from 21% to 99%

ACCESSORIES

	code	page
Bluelink Pro	414317	23
Dive Link 2 USB	414316	23

INTERFACE

BLUELINK PRO

NEW

code: 414317

- TO DOWNLOAD THE LOGBOOK OF A DIVE COMPUTER USING THE BLUETOOTH LOW ENERGY TECHNOLOGY (QUAD, QUAD AIR, PUCK PRO +, SMART)
- REQUIRES THE DIVESSI APP (ANDROID, IOS)



DIVE LINK 2 USB

code: 414316

- FOR DOWNLOADING THE DIVE COMPUTER MEMORY TO PC OR MAC (QUAD, QUAD AIR, PUCK PRO +, SMART)
- REQUIRED SOFTWARE: DIVE ORGANIZER (PC) OR DIVERS DIARY (MAC)



DRAK USB

code: 414308

- FOR DOWNLOADING THE DIVE COMPUTER MEMORY TO PC OR MAC (ALL PUCK CONSOLES)
- REQUIRED SOFTWARE: DIVE ORGANIZER (PC) OR DIVERS DIARY (MAC)



PUCK AIR

code: 414161

code: 414162 · 414163 Southern Hemisphere

- COMPACT YET FULL FEATURED AIR INTEGRATED DIVE COMPUTER
- GAS TIME CALCULATION
- SEGMENT DISPLAY WITH DOT MATRIX INSERT
- INTUITIVE USER INTERFACE WITH ONE-BUTTON SIMPLICITY
- AVAILABLE WITH ANALOG COMPASS
- LOGBOOK CAPACITY 35 HOURS OF DIVE PROFILE AT 20-SECOND SAMPLING RATE
- USER-REPLACEABLE BATTERY
- MULTIPLE LANYARD ATTACHMENT POINTS



PUCK AIR
STANDARD VERSION



PUCK AIR
WITH COMPASS

TECHNICAL FEATURES

Battery	Type	CR2450
	Duration	200-300 dives
Nitrox		EAN from 21% to 50%

ACCESSORIES

	code	page
Drak USB Interface	414308	23

MISSION 1C WRIST COMPASS

code: 414404

- OIL BATH
- SIDE VIEW WINDOW
- WRIST MOUNT CONSOLE



PUCK CONSOLES

code: 414420 Mission Puck 2

code: 414421 Mission Puck 3

- COMPACT CONSOLE WITH FULL FEATURED COMPUTER AND ANALOG PRESSURE GAUGE
- AVAILABLE WITH ANALOG COMPASS
- INTUITIVE USER INTERFACE WITH ONE-BUTTON SIMPLICITY
- LOGBOOK CAPACITY 35 HOURS OF DIVE PROFILE AT 5-SECOND SAMPLING RATE
- USER-REPLACEABLE BATTERY
- MULTIPLE LANYARD ATTACHMENT POINTS



MISSION PUCK 2



MISSION PUCK 3

TECHNICAL FEATURES

Battery	Type	CR2450
	Duration	200-300 dives
Nitrox		EAN from 21% to 50%

ACCESSORIES

	code	page
Drak USB Interface	414308	23

HANDY COMPASS

code: 414504 · 414506 Southern hemisphere

- OIL BATH
- SIDE VIEW WINDOW
- SPECIAL HOUSING FOR CLIPPING TO BCD



MISSION 1

code: 414417

- BRASS CASE
- TECHNOLYMER WINDOW
- PHOSPHORESCENT DIAL FACE
- PROTECTIVE RUBBER CONSOLE
- MULTIPLE ATTACHMENT POINTS



MISSION 2

code: 414418

- PRESSURE GAUGE:
- BRASS CASE
 - TECHNOLYMER WINDOW
 - PHOSPHORESCENT DIAL FACE
- DEPTH GAUGE:
- OIL BATH
 - PHOSPHORESCENT DIAL FACE
 - MAX DEPTH INDICATOR
 - LINEAR SCALE
- CONSOLE:
- PROTECTIVE RUBBER COVER WITH MULTIPLE ATTACHMENT POINTS



MISSION 2C

code: 414423

- PRESSURE GAUGE:
- BRASS CASE
 - TECHNOLYMER WINDOW
 - PHOSPHORESCENT DIAL FACE
- COMPASS:
- OIL BATH
 - SIDE VIEW WINDOW
- CONSOLE:
- PROTECTIVE RUBBER COVER WITH MULTIPLE ATTACHMENT POINTS



MISSION 3

code: 414419

- PRESSURE GAUGE:
- BRASS CASE
 - TECHNOLYMER WINDOW
 - PHOSPHORESCENT DIAL FACE
- DEPTH GAUGE:
- OIL BATH
 - PHOSPHORESCENT DIAL FACE
 - MAX DEPTH INDICATOR
 - LINEAR SCALE
- COMPASS:
- OIL BATH
 - SIDE VIEW WINDOW
- CONSOLE:
- PROTECTIVE RUBBER COVER WITH MULTIPLE ATTACHMENT POINTS



MISSION DIGITAL CHRONO

code: 414814

- DIGITAL CHRONOGRAPH WITH BACK LIGHT
- WATER RESISTANT 20atm/293psi OR 200m/660ft
- HIGH-QUALITY SWISS QUARTZ MOVEMENT
- DAILY ALARM AND HOURLY TIME SIGNAL
- COUNTDOWN TIMER
- DIGITAL TIMEZONE AND DATE
- SECOND DIGITAL TIMEZONE
- FLUORESCENT DIGITS
- STAINLESS STEEL



MISSION PRO

code: 414813

- WATER RESISTANT 20atm/293psi OR 200m/660ft
- HIGH-QUALITY SWISS QUARTZ MOVEMENT
- FLUORESCENT DIGITS
- SILICONE STRAP
- STAINLESS STEEL CASE



ACCESSORIES

LED TANK MODULE

NEW

code: 414319

- TRANSMITS TANK INFORMATION
- COLOR LED FOR QUICK TANK CHECK ON THE SURFACE
- COLOR LED ALERTS BUDDY OF LOW AIR SITUATION DURING DIVE
- PERMANENT PAIRING
- EN250:2014 CERTIFIED TO 300BAR
- BATTERY TYPE: CR123A, USER REPLACEABLE



ICON TANK MODULE

code: 414311*

- TRANSMITS TANK INFORMATION
- THE ICON HD CAN THEN DISPLAY TANK PRESSURE, TTR (TIME TO RESERVE) AND GAS CONSUMPTION
- PERMANENT PAIRING
- EN250:2014 CERTIFIED TO 300BAR
- BATTERY TYPE: CR123A, USER REPLACEABLE
- BATTERY DURATION: 180 - HOUR DIVE



*Until stock lasts

QUAD DISPLAY PROTECTOR

NEW

code: 415182

- EASY TO INSTALL
- PREVENTS FROM SCRATCHES
- SOFT AND DURABLE
- ULTRA CLEAR



MATRIX / SMART DISPLAY PROTECTOR

code: 415173

- PERFECT FIT AND EASY TO INSTALL
- PREVENTS FROM SCRATCHES, DIRT AND SAND
- SOFT AND DURABLE
- ULTRA CLEAR
- A PACK CONTAINS 2 PIECES
- ALSO FITS THE SMART



MATRIX STRAP EXTENSION

code: 44200966

- FOR USE WITH THICK WET OR DRY SUITS
- FOR MATRIX ONLY



SMART STRAP EXTENSION

code: 44201190

- FOR USE WITH THICK WET OR DRY SUITS
- FOR SMART ONLY



MATRIX METAL STRAP

code: 414811

- STYLISH METAL STRAP
- EXTENSION FOR WETSUIT
- LOCK SYSTEM
- STAINLESS STEEL
- BLACK AND WHITE OPTIONS
- FOR MATRIX ONLY



TECHNICAL SPECIFICATION



Computer	Quad Air	Quad	Icon HD Black	Matrix	Smart	Puck Pro +	Puck Air	Puck Air with compass	Mission Puck 2	Mission Puck 3
Code	414169	414134	414130	414170	414129	414135	414161	414162 NO 414163 SO	414420	414421
Colors	BKBK	BK, WH	-	BKBK, WHWH	BKBK, BKGR, BKRD, BKWH, WHLM, WHLL	BKBK, BKWH	-	-	-	-
LCD COLOR DISPLAY			■							
FULL DOT MATRIX			■	■						
SEGMENT / MATRIX AREA DISPLAY							■	■		
SEGMENT DISPLAY	■	■			■	■			■	■
AIR INTEGRATED	■		■				■	■		
GAS SWITCHING	■	■	■	■	■	■				
SOFTWARE UPGRADEABILITY	■	■	■	■	■	■				
USB CHARGER			■	■						
ONE BUTTON CONTROL						■	■	■	■	■
MINERAL GLASS	■	■	■	■	■	■				
Max displayed depth	150 m (492 ft)	150 m (492 ft)	150 m (492 ft)	150 m (492 ft)	150 m (492 ft)	150 m (492 ft)	150 m (492 ft)	150 m (492 ft)	150 m (492 ft)	150 m (492 ft)
Rechargeable batteries			■	■						
User replaceable batteries	■	■	■	■	■	■	■	■	■	■
Residual nitrogen reset	■	■	■	■	■	■	■	■	■	■
Option to exclude audible alarms	■	■	■	■	■	■	■	■	■	■
Ascent rate indicator	■	■	■	■	■	■	■	■	■	■
Memory capacity	> 100 hr	38 hr	> 100 hr	36 hr	36 hr	36 hr	36 hr	36 hr	36 hr	36 hr
Profile sampling rates	5 s	5 s	5 s	5 s	5 s	5 s	20 s	20 s	5 s	5 s
Dual time				■	■					
Stopwatch	■ ***	■ ***	■ **	■ *	■					
Daily alarm			■	■	■					

* Dive mode / ** Compass and bottom timer modes only / *** Bottom timer mode

SOFTWARE

DIVE ORGANIZER

- FULL-FEATURED LOGBOOK MANAGEMENT SOFTWARE
- ALLOWS UPGRADING OF FIRMWARE ON COMPATIBLE DIVE COMPUTERS
- ALLOWS UPLOADING OF MAPS AND IMAGES TO ICON HD
- FEATURES TISSUE SATURATION GRAPH WITH DETAILED EVOLUTION DURING THE DIVE
- FOR PC ONLY

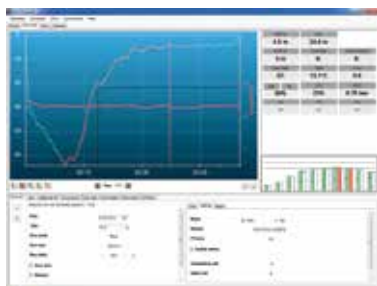

DIVERS DIARY

- FULL-FEATURED LOGBOOK MANAGEMENT SOFTWARE
- ALLOWS UPGRADING OF FIRMWARE ON COMPATIBLE DIVE COMPUTERS
- FEATURES TISSUE SATURATION GRAPH WITH DETAILED EVOLUTION DURING THE DIVE
- FOR MAC ONLY

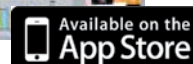



**GAUGE
KEEPER**

SLS SLIDE & LOCK

SLS

SAFARI



BCD'S

SLS SLIDE & LOCK

DRAGON SLS / KAILA SLS

code Dragon SLS: 417223

code Kaila SLS: 417363

- SUPERBLY COMFORTABLE AND STABLE YET TOUGH AND DURABLE
- AIRCELL SLIDES ON SHOULDERS FOR INCREASED COMFORT WHEN INFLATED
- POSITION OF THE CORRUGATED HOSE RETAINING EPAULETTE CAN BE ADJUSTED
- HIGH LIFT AIRCELL WITH "DRAGON" WINGLETS
- SMART TRIM WEIGHT POSITIONING
- SLS WEIGHT SYSTEM
- SWIVEL BUCKLES: 50mm ON THE DRAGON, 40mm ON THE KAILA
- HIGH CAPACITY CARGO POCKETS WITH STRETCH PANELS
- ADJUSTABLE CUMMERBUND
- MONOPLATE BACKPACK FITS SINGLE OR DOUBLE TANKS
- VISUAL CONFIRMATION OF PROPER WEIGHT POUCH INSERTION
- PERSONALIZABLE LABEL ON WEIGHT POCKETS



TECHNICAL FEATURES

Sizes	XS	S	M	L	XL
Weight	4,2 kg / 9.2 lb	4,2 kg / 9.2 lb	4,4 kg / 9.7 lb	4,5 kg / 9.9 lb	4,75 kg / 10.5 lb
Buoyancy	130 N (13,8 kg / 30 lb)	150 N (16 kg / 35 lb)	180 N (18,3 kg / 38 lb)	200 N (21 kg / 46 lb)	230 N (23,9 kg / 53 lb)

She Dives Sizes	XXS	XS	S	M	L
Weight	4,1 kg / 9 lb	4,2 kg / 9.2 lb	4,2 kg / 9.2 lb	4,4 kg / 9.7 lb	4,5 kg / 9.9 lb
Buoyancy	110 N (10,8 kg / 24 lb)	130 N (13,8 kg / 30 lb)	150 N (16 kg / 35 lb)	180 N (18,3 kg / 38 lb)	200 N (21 kg / 46 lb)

ACCESSORIES

	code	page
BCD attachment Kit	415178	35
Tank strap set for doubles	415090	35

DETAILS



"Dragon" aircell



High capacity cargo pockets with stretch panels



Adjustable epaulette



50mm swivel buckles

PURE SLS

code: 417361

- COMFORTABLE AND STABLE BACK BUOYANCY BC WITH 18kg LIFT (40 lbs)
- STREAMLINED
- SWIVEL SHOULDER BUCKLES
- SMART TRIM WEIGHT POSITIONING
- SLS WEIGHT SYSTEM
- ROLL-DOWN CARGO POCKET
- WAIST STRAP ALLOWS MAXIMUM ADJUSTABILITY
- CUSTOMIZABLE AND TRAVEL FRIENDLY
- MONOPLATE BACKPACK FITS SINGLE OR DOUBLE TANKS
- VISUAL CONFIRMATION OF PROPER WEIGHT POUCH INSERTION
- PERSONALIZABLE LABEL ON WEIGHT POCKETS



TECHNICAL FEATURES

Sizes	XS	S	M	L	XL
Weight	3,6 kg / 7.9 lb	3,7 kg / 8.1 lb	3,7 kg / 8.1 lb	3,8 kg / 8.3 lb	3,8 kg / 8.3 lb
Buoyancy	170 N (18,1 kg / 40 lb)	170 N (18,1 kg / 40 lb)	170 N (18,1 kg / 40 lb)	170 N (18,1 kg / 40 lb)	170 N (18,1 kg / 40 lb)

ACCESSORIES

	code	page
BCD attachment Kit	415178	35
Tank strap set for doubles	415090	35
Crotch Strap	415744	35
Optional Cargo Pocket	417961	35

DETAILS



Roll-down pocket



Trim weight pockets



Swivel shoulder buckle



SLS weight system

BOLT SLS

code: 417362

- SUPERBLY COMFORTABLE AND STABLE BACK BUOYANCY BC WITH 21kg LIFT (46 lbs)
- STREAMLINED
- SWIVEL SHOULDER BUCKLES
- SMART TRIM WEIGHT POSITIONING
- SLS WEIGHT SYSTEM
- ROLL-DOWN CARGO POCKET
- ADJUSTABLE CUMMERBUND
- TRAVEL FRIENDLY
- MONOPLATE BACKPACK FITS SINGLE OR DOUBLE TANKS
- VISUAL CONFIRMATION OF PROPER WEIGHT POUCH INSERTION
- PERSONALIZABLE LABEL ON WEIGHT POCKETS



TECHNICAL FEATURES

Sizes	XS	S	M	L	XL
Weight	3,6 kg / 7.9 lb	3,7 kg / 8.1 lb	3,7 kg / 8.1 lb	3,9 kg / 8.6 lb	3,9 kg / 8.6 lb
Buoyancy	200 N (21 kg / 46 lb)	200 N (21 kg / 46 lb)	200 N (21 kg / 46 lb)	200 N (21 kg / 46 lb)	200 N (21 kg / 46 lb)

ACCESSORIES

	code	page
BCD attachment Kit	415178	35
Tank strap set for doubles	415090	35

DETAILS



Roll-down pocket



Trim weight pockets



Swivel shoulder buckle



SLS weight system

QUANTUM SLS

code: 417357

- MONOPLATE BACKPACK FITS SINGLE TANK OR DOUBLES
- SWIVEL BUCKLES AND D-RING ATTACHMENT ON SIDE LOBE
- SLS WEIGHT SYSTEM
- VISUAL CONFIRMATION OF PROPER WEIGHT POUCH INSERTION
- PERSONALIZATION LABEL ON WEIGHT POUCHES
- STRETCH CARGO POCKETS
- OPENINGS ON SIDE LOBES FOR HOSE STORAGE
- TRIM WEIGHT POCKETS
- OPTIONAL BC ATTACHMENT KIT
- OPTIONAL TANK STRAP SET FOR DOUBLES UP TO 2 X 12L / 2 X 80cuft



HYBRID AT

code: 417334

- FOLDABLE BACKPACK
- AIRTRIM FOR FAST AND INTUITIVE BUOYANCY CONTROL
- MRS PLUS MODULAR INTEGRATED WEIGHT SYSTEM



TECHNICAL FEATURES

Sizes	XS	S	M	L	XL
Weight	4,2 kg / 9.2 lb	4,2 kg / 9.2 lb	4,4 kg / 9.7 lb	4,5 kg / 9.9 lb	4,6 kg / 10.1 lb
Buoyancy	120 N (12,2 kg / 27 lb)	130 N (13,8 kg / 30 lb)	150 N (16 kg / 35 lb)	180 N (18,3 kg / 38 lb)	200 N (21 kg / 46 lb)

ACCESSORIES

	code	page
BCD Attachment Kit	415178	35
Tank strap set for doubles	415090	35

TECHNICAL FEATURES

Sizes	XS/S	M/L	XL
Weight	3,9 kg / 8.6 lb	4 kg / 8.8 lb	4,2 kg / 9.2 lb
Buoyancy	145 N (14,8 kg / 32,6 lb)	200 N (21 kg / 46 lb)	235 N (24 kg / 52.9 lb)

ACCESSORIES

	code	page
BCD attachment Kit	415178	35

PRESTIGE SLS

NEW

code: 417224 BL

code: 417225 WH

- EXCELLENT LIFT CAPACITY
- LIGHT, STRONG AND DURABLE DENIER 420
- IMPROVED FIT: SWIVELING BUCKLES, SHOULDERS, LOW-CUT AIRCELL
- SLS INTEGRATED WEIGHT SYSTEM
- 3-DIMENSIONAL ZIPPERED SELF-DRAINING POCKETS
- 2 REAR TRIM WEIGHT POCKETS
- REDUCED WEIGHT: TRAVEL FRIENDLY



TECHNICAL FEATURES

Sizes BL	XS	S	M	L	XL
Weight	3,4 kg / 7.5 lb	3,5 kg / 7.7 lb	3,85 kg / 8.5 lb	3,9 kg / 8.6 lb	4 kg / 8.8 lb
Buoyancy	120 N (12,2 kg / 27 lb)	130 N (13,8 kg / 30 lb)	150 N (16 kg / 35 lb)	180 N (18,3 kg / 38 lb)	200 N (21 kg / 46 lb)

Sizes WH	XXS	XS	S	M	L
Weight	3,3 kg / 7.3 lb	3,4 kg / 7.5 lb	3,5 kg / 7.7 lb	3,85 kg / 8.5 lb	3,9 kg / 8.6 lb
Buoyancy	100 N (10,8 kg / 24 lb)	120 N (12,2 kg / 27 lb)	130 N (13,8 kg / 30 lb)	150 N (16 kg / 35 lb)	180 N (18,3 kg / 38 lb)

ACCESSORIES

	code	page
BCD attachment Kit	415178	35
Tank strap set for doubles	415090	35

DETAILS



SLS weight system



Trim weight pocket



3D zippered pocket



Swivel buckles

code: 417364

- IDEAL FOR THOSE WHO WANT TO GET STARTED WITH THEIR DIVING ADVENTURE
- STANDARD BCD
- EXCELLENT BUOYANCY AND FIT
- LIGHT, STRONG AND DURABLE DENIER 420
- STOWAGE FOR OCTOPUS AND PRESSURE GAUGE
- MONOPLATE BACKPACK
- 2 LARGE CARGO POCKETS
- UPGRADEABLE INTEGRATED WEIGHT SYSTEM



TECHNICAL FEATURES

Sizes	XS	S	M	L	XL
Weight	2,5 kg / 5.5 lb	2,6 kg / 5.7 lb	2,8 kg / 6.2 lb	2,8 kg / 6.2 lb	2,9 kg / 6.4 lb
Buoyancy	140 N (14,2 kg / 31.3 lb)	150 N (16 kg / 35 lb)	160 N (16,3 kg / 35.9 lb)	200 N (21 kg / 46 lb)	235 N (24 kg / 52.9 lb)

ACCESSORIES

	code	page
Tank strap set for doubles	415090	35
Standard Buckle Weight System	417962	35



ACCESSORIES

SLS SLIDE&LOCK SYSTEM

NEW

code: 417959 - SMALL: 4 kg / 9 lbs (PAIR)

code: 417960 - LARGE: 6 kg / 13 lbs (PAIR)

- STURDY ZIPPERED POCKET
- EASY TO SLIDE INTO POCKET
- VISUAL AID TO SEE IF SYSTEM IS PROPERLY ENGAGED
- SAFEST SYSTEM AVAILABLE
- EASY TO USE WITH THICK GLOVES



PAT PENDING

STANDARD BUCKLE WEIGHT SYSTEM

NEW

code: 417962 (PAIR)

- ADD-ON TO UPGRADE BCD WITH STANDARD BUCKLE WEIGHT SYSTEM
- ZIPPERED POCKET
- EASY USE WITH THICK GLOVES
- ONE SIZE FITS ALL
- WEIGHT CAPACITY: 6KG/13LBS (EACH)



MRS PLUS

code: 417955 - SMALL: 4 kg / 9 lbs (PAIR)

code: 417954 - LARGE: 6 kg / 13 lbs (PAIR)

- ZIPPERED POCKET
- INTERNAL VELCRO FOR MULTIPLE SECTIONS



KIT MRS PLUS

code: 417958 (PAIR)

- OPTIONAL FOR UPGRADING BCDS WITH MRS PLUS
- EASY TO INSTALL
- ZIPPERED POCKET
- INTERNAL VELCRO FOR MULTIPLE SECTIONS
- LARGE WEIGHT CAPACITY: 6 kg/13 lbs



TANK STRAP SET FOR DOUBLES

code: 415090

- ALLOWS TWIN TANKS UP TO 2 X 12L / 2 X 80 cuft ON SELECTED BCDS



CARGO POCKET

code: 417961

- HIGH VOLUME POCKET
- REPLACES SLS SYSTEM
- FOR PURE SLS ONLY



BCD ATTACHMENT KIT

code: 415178

- IDEAL SOLUTION FOR YOUR EXTENSION POLE
- EASY TO INSTALL
- FITS ONTO MARES BCD'S



PAT PENDING

CROTCH STRAP

code: 415744

- CAN BE USED WITH BACKMOUNTED BCD'S
- ULTIMATE STABILITY



LANYARD STAINLESS SPIRAL WITH RING

code: 415732

- STAINLESS STEEL SPIRAL CABLE
- PROVIDES EXTENSION MORE THAN 50 cm/20 in
- QUICK RELEASE BUCKLE
- TO AVOID LOOSE ACCESSORIES



STANDARD RETRACTOR

code: 415715

- STAINLESS STEEL CABLE
- HEAVY DUTY HOOKS ON BOTH SIDES
- MORE THAN 60 cm/23,5 in WHEN EXTENDED



LANYARD MALE/FEMALE

code: 415716

- MULTI FUNCTIONAL
- PLUG IN AND USE WITH MOST STANDARD BUCKLE SYSTEMS
- FAST LEASH OPENING FOR SIMPLE ATTACHMENT



LANYARD SPIRAL WITH RING

code: 415717

- SPIRAL CABLE PROVIDES MORE THAN 50 cm/20 in EXTENSION
- STAINLESS STEEL RING
- QUICK RELEASE BUCKLE



LANYARD OPEN LOOP

code: 415722

- MULTI FUNCTIONAL LANYARD WITH OPEN LOOP
- THE LOOP ALLOWS WIDE ATTACHMENT FUNCTIONALITY
- MALE/FEMALE QUICK RELEASE BUCKLE



CONSOLE HOLDER WITH VELCRO

code: 415718

- STRONG VELCRO TO HOLD AND RELEASE WHEN NEEDED
- QUICK RELEASE SYSTEM USED FOR CONSOLE AND OCTOPUS
- QUICK ADJUSTING ROPE LEASH FOR FLEXIBLE FASTENING



HOSE RETAINER

code: 415157

- HEAVY DUTY HOOKS
- SWIVEL SOLUTION
- TWO POSITIONS TO HANG HOSES



TECHNICAL SPECIFICATIONS



BCD	Dragon SLS	Kaila SLS	Pure SLS	Bolt SLS	Quantum SLS	Hybrid AT	Prestige SLS		Prime	
Code	417223	417363	417361	417362	417357	417334	417224 BL	417225 WH	417364	
Sizes	XS · S · M · L · XL	XXS · XS · S · M · L	XS · S · M · L · XL	XS · S · M · L · XL	XS · S · M · L · XL	XS/S · M/L · XL	XS · S · M · L · XL	XXS · XS · S · M · L	XS · S · M · L · XL	
FUSION BLADDER	■	■				■				
CLASSIC BLADDER					■		■		■	
BACKMOUNTED			■	■						
ERGO INFLATOR	■	■	■	■	■		■		■	
AIRTRIM						■				
MONOPLATE BACKPACK	■	■	■	■	■		■		■	
FOLDABLE BACKPACK						■				
SUSPENSION SYSTEM						■				
Materials (external/internal)	Cordura®420 / Cordura®420	Cordura®420 / Cordura®420	Cordura®420 / Cordura®420	Cordura®420 / Cordura®420	Cordura®420 / Cordura®420	Cordura®420 / Cordura®420	Cordura®420 / Cordura®420		Cordura®420 / Cordura®420	
D-rings	Stainless steel	5	5	7	6	6	2			
	Aluminium						6			
	Heavy-duty Technopolymer					3	4		5	
Weight (size L)	Kg	4,5	4,3	3,8	3,9	4,5	3,9		2,8	
	lb	9.9	9.5	8.3	8.6	9.9	8.6		6.2	
Buoyancy	XXS		110 N (10,8 kg / 24 lb)				100 N (10,8 kg / 24 lb)			
	XS	130 N (13,8 kg / 30 lb)	130 N (13,8 kg / 30 lb)	170 N (18,1 kg / 40 lb)	200 N (21 kg / 46 lb)	120 N (12,2 kg / 27 lb)	145 N (14,8 kg / 32.6 lb)	120 N (12,2 kg / 27 lb)	120 N (12,2 kg / 27 lb)	140 N (14,2 kg / 31.3 lb)
	S	150 N (16 kg / 35 lb)	150 N (16 kg / 35 lb)	170 N (18,1 kg / 40 lb)	200 N (21 kg / 46 lb)	130 N (13,8 kg / 30 lb)	145 N (14,8 kg / 32.6 lb)	130 N (13,8 kg / 30 lb)	130 N (13,8 kg / 30 lb)	150 N (16 kg / 35 lb)
	M	180 N (18,3 kg / 38 lb)	180 N (18,3 kg / 38 lb)	170 N (18,1 kg / 40 lb)	200 N (21 kg / 46 lb)	150 N (16 kg / 35 lb)	200 N (21 kg / 46 lb)	150 N (16 kg / 35 lb)	150 N (16 kg / 35 lb)	160 N (16,3 kg / 35.9 lb)
	L	200 N (21 kg / 46 lb)	200 N (21 kg / 46 lb)	170 N (18,1 kg / 40 lb)	200 N (21 kg / 46 lb)	180 N (18,3 kg / 38 lb)	200 N (21 kg / 46 lb)	180 N (18,3 kg / 38 lb)	180 N (18,3 kg / 38 lb)	200 N (21 kg / 46 lb)
	XL	230 N (23,9 kg / 53 lb)		170 N (18,1 kg / 40 lb)	200 N (21 kg / 46 lb)	200 N (21 kg / 46 lb)	235 N (24 kg / 52.9 lb)	200 N (21 kg / 46 lb)		235 N (24 kg / 52.9 lb)
SLS	417959 (small - max 4 kg)	XS · S	XXS · XS · S	XS · S · M · L · XL	XS · S · M	XS · S	-	XS · S	XXS · XS · S	-
	417960 (large - max 6 kg)	M · L · XL	M · L		L · XL	M · L · XL		M · L · XL	M · L	
MRS Plus	417955 (small - max 4 kg)					XS/S				
	417954 (large - max 6 kg)					M/L · XL				
Standard Buckle	417962 (max 6kg)								■	



SEAL SKIN 2

mares
SEAL SKIN

SUITS

SEAL SKIN

NEW

code: 412369 Man

code: 412370 She Dives

- THE REVOLUTION IN COLD WATER SUITS
- INCREASED THERMAL COMFORT WITH S-SEAL TECHNOLOGY
- GLIDESKIN WRISTS AND ANKLES
- ZIPPERS ON ANKLES
- COMFORTABLE NECK CLOSURE
- SUPRATLEX KNEEPAD
- EASY DRESSING AND DOFFING THANKS TO ULTRASTRETCH NEOPRENE
- INSTRUMENT GRIP AREA ON BOTH WRISTS
- INTEGRATED BUCKLE ON THE LEG FOR HOOD ATTACHMENT OR ATTACHMENT OF THE DEDICATED FLEXA SMART POCKET (SOLD SEPARATELY)



TECHNICAL FEATURES

Thickness	6 mm						
Fabric type	Ultrastretch Neoprene						
Sizes Man		2	3	4	5	6	7
Sizes She Dives	1	2	3	4	5		

DETAILS



FLEXA THERM

code: 412069 Man

code: 412070 She Dives

- MAXIMUM THERMAL COMFORT, PERFECT FIT
- HORIZONTAL SOFT AND FLEXIBLE WATERPROOF MASTER SEAL ZIP ON BACK
- HANDY POCKETS WITH ZIP AND D-RING
- HOOD WITH FAST AIR RELEASE AND EAR EQUALIZATION SYSTEM



TECHNICAL FEATURES

Thickness	6,5 mm					
Fabric type	Ultrastretch Neoprene					
Sizes Man	2	3	4	5	6	7
Sizes She Dives	1	2	3	4	5	

FLEXA



8-6-5 mm

code: 412337 Man

code: 412339 She Dives

5-4-3 mm

code: 412338 Man

code: 412340 She Dives

3-2-2 mm

code: 412348 Man

code: 412349 She Dives

- THE ULTIMATE EXPRESSION OF TRILASTIC MATERIAL DESIGN
- VARIED THICKNESSES STRATEGICALLY PLACED IN DIFFERENT AREAS OF THE BODY
- NEW SOFT ERGONOMIC CUSTOM CLOSURE
- BACK AND SHOULDERS COMFORT SYSTEM: AN ADDITIONAL LAYER OF NEOPRENE STITCHED IN THE BACK FOR ADDED COMFORT AND PROTECTION
- FRONT ZIP WITH SMOOTH NEOPRENE FLAP FOR GREATER COMFORT AND ISOLATION
- INTEGRATED BUCKLE ON THE LEG FOR HOOD ATTACHMENT OR ATTACHMENT OF THE DEDICATED FLEXA SMART POCKET (SOLD SEPARATELY)
- INSTRUMENT GRIPS ON BOTH WRISTS



Shoulder color changes with suit thickness



TECHNICAL FEATURES

Thickness	8-6-5 / 5-4-3 / 3-2-2 mm						
Fabric type	Ultrastretch Neoprene						
Sizes Man		2	3	4	5	6	7
Sizes She Dives	1	2	3	4	5		

SMART POCKET

code: 412341

- CAN BE INSTALLED ON ALL NEW MARES SUITS FEATURING THE INTEGRATED SMART POCKET SYSTEM VIA AN EASY AND INTUITIVE CLIP SYSTEM
- INTEGRATED GRAPHIC PERFECTLY MATCHES ALL MARES SUITS
- GRIP PROTECTION SYSTEM TO AVOID LOOSENING WHEN DIVING OR DAMAGE TO THE SUIT



PIONEER

7 mm

code: 412346 Man

code: 412347 She Dives

5 mm

code: 412344 Man

code: 412345 She Dives

- NON-RUBBER CUSTOM CLOSURE
- ZIPPERS ON THE ANKLES (ONLY ON THE 7 mm VERSION) MAKE DONNING AND DOFFING EFFORTLESS
- THE HOOD VENTING SYSTEM ASSISTS THE RELEASE OF AIR, OPTIMIZING EQUALIZATION AND COMFORT
- NEW NECK CLOSURE WITH ANTI-ABRASION VELCRO PREVENTS WETSUIT DAMAGE
- INSTRUMENT GRIPS ON BOTH WRISTS
- HOOD KEEPER D-RING ON THE RIGHT LEG
- KNEEPAD IN ANTI-ABRASIVE MATERIAL



TECHNICAL FEATURES

Thickness	7 mm / 5 mm						
Fabric type	Neoprene & Ultrastretch Neoprene						
Sizes Man		2	3	4	5	6	7
Sizes She Dives	1	2	3	4	5		

DUAL

NEW

code: 412375 Man

code: 412376 She Dives

- TRADITIONAL COMBINATION OF A LONG JOHN AND A JACKET
- THICKEST NEOPRENE AREA CONCENTRATED ON CHEST AND BACK AREAS WHERE THERMAL PROTECTION IS MOST NEEDED
- GLIDESKIN WRIST AND ANKLE SEALS
- LEAVES ARMS AND LEGS WITH A FEELING OF FREEDOM AND MOBILITY
- STRATEGICALLY PLACED ELASTIC INSERTS
- INSTRUMENT GRIP AREA ON BOTH WRISTS
- KNEEPAD IN ANTI-ABRASIVE MATERIAL



TECHNICAL FEATURES

Thickness	5 mm						
Fabric type	Neoprene						
Sizes Man		2	3	4	5	6	7
Sizes She Dives	1	2	3	4	5		

REEF

NEW

code: 412382 Man

code: 412383 She Dives

- NEW MODERN DESIGN WITH SHOULDER GRIP AREA
- COOL, STRETCHY AND IDEAL FOR TEMPERATE WATER
- ERGONOMIC, COMFORTABLE VELCRO CLOSURE AND BACK ZIP PULLER
- WRIST, ANKLE AND NECK SEALS ENRICHED WITH AQUIASTOP FINISH
- ALSO SUITABLE FOR MULTIPLE WATERSPORTS



CORAL

NEW

code: 412386 Man

code: 412387 She Dives

- COMFORTABLE SECOND SKIN FOR TROPICAL DIVES
- EASY DONNING AND DOFFING
- CAN ALSO BE WORN AS AN UNDERSUIT
- ELASTIC BANDS ON WRISTS AND ANKLES FOR BETTER FIT ALONE OR UNDER A SUIT
- METALITE FABRIC INSIDE WITH HEAT RETAINING EFFECT
- ALSO SUITABLE FOR MULTIPLE WATERSPORTS



TECHNICAL FEATURES

Thickness	3 mm						
Fabric type	Neoprene						
Sizes Man		2	3	4	5	6	7
Sizes She Dives	1	2	3	4	5		

TECHNICAL FEATURES

Thickness	0,5 mm						
Fabric type	Neoprene						
Sizes Man		2	3	4	5	6	7
Sizes She Dives	1	2	3	4	5		

FLEXA CORE

code: 412342 Man

code: 412343 She Dives

- ULTRA-ELASTIC SHORTY WITH ATTACHED HOOD FOR GREATER THERMAL COMFORT
- COMPLETES THE FAMILY OF FLEXA SUITS, BUT CAN ALSO BE USED WITH ANY MARES SUIT
- CAN BE USED AS A STAND-ALONE PRODUCT
- INTEGRATED BUCKLE ON THE LEG FOR HOOD ATTACHMENT OR ATTACHMENT OF A CUSTOMIZED POCKET (SOLD SEPARATELY)



2nd SKIN SHORTY

NEW

code: 412371 Man

code: 412372 She Dives

- MADE WITH METALITE (HEAT REFLECTING AND HEAT RETAINING PROPERTIES)
- BEST WORN UNDERNEATH THE STEAMER
- EXTREMITIES IN GLIDE SKIN ON THE LEGS, TOGETHER WITH THE ERGONOMIC NECK CLOSURE AND THE 0,5 mm HOOD, CREATE AN EXTREMELY WATER-RESISTANT SHORTY
- CAN ALSO BE USED AS A SNORKELING SUIT



TECHNICAL FEATURES

Thickness	4 mm						
Fabric type	Ultrastretch Neoprene						
Sizes Man		2	3	4	5	6	7
Sizes She Dives	1	2	3	4	5		

TECHNICAL FEATURES

Thickness	1,5 mm						
Fabric type	Ultrastretch Neoprene / Metalite inside						
Sizes Man		2	3	4	5	6	7
Sizes She Dives	1	2	3	4	5		

REEF SHORTY

NEW

code: 412384 Man

code: 412385 She Dives

- COOL, STYLISH, LIGHTWEIGHT AND EXCELLENT FOR WARM WATER DIVES AND LONG SNORKELING SESSIONS
- HIGH LEVEL OF FINISH ON ALL DETAILS INCLUDING NECK CUSTOM CLOSURE AND BACK ZIP PULLER
- ERGONOMIC COMFORTABLE VELCRO CLOSURE AND BACK ZIP PULLER
- AQUASTOP FINISH ON ARMS AND THIGHS
- ALSO SUITABLE FOR MULTIPLE WATERSPORTS



TECHNICAL FEATURES

Thickness	2,5 mm						
Fabric type	Neoprene						
Sizes Man		2	3	4	5	6	7
Sizes She Dives	1	2	3	4	5		

FLEXA VEST

code: 412537 Man

code: 412538 She Dives

- INCREASES HEAT RETENTION IN COLD WATER DIVING
- IDEAL FOR WEARING UNDER FLEXA SUITS
- LOW COMPRESSION NEOPRENE ON THE TOP OF THE HEAD



TECHNICAL FEATURES

Thickness	3 mm						
Fabric type	Ultrastretch Neoprene						
Sizes Man		2	3	4	5	6	7
Sizes She Dives	1	2	3	4	5		

GOLD SKIN

NEW

code: 412411 Man

code: 412412 She Dives

- NEOPRENE WITH OUTER COVERING AND OPEN-CELL INTERIOR WITH GOLD SKIN COATING



TECHNICAL FEATURES

Thickness	2 mm						
Fabric type	Neoprene with open cell interior gold skin coating						
Sizes Man		2	3	4	5	6	7
Sizes She Dives	1	2	3	4	5		

SCUBA RANGER

NEW

code: 412373 Jacket

code: 412374 Long John

- DEDICATED KID'S TWIN SUIT: LONG-SLEEVED, HOODED JACKET AND LONG JOHN (SOLD SEPARATELY)
- JACKET AND LONG JOHN CAN BE WORN TOGETHER OR SEPARATELY ACCORDING TO WATER TEMPERATURE
- DEDICATED DESIGN AND COLOR FOR KIDS: SHOULDERS AND ZIPPERS IN LIME
- VARIED THICKNESSES STRATEGICALLY PLACED IN DIFFERENT AREAS OF THE BODY FOR COMFORT AND FREEDOM OF MOVEMENT
- EASY DORNING AND DOFFING



TECHNICAL FEATURES

Thickness	5 mm			
Fabric type	Neoprene			
Sizes Junior	-3	-2	-1	0

THERMO GUARD SHORTY

code: 412536

- ALWAYS HANDY
- EXTREMELY VERSATILE PRODUCT THAT CAN BE USE AS A FIRST LAYER OR AS A STANDALONE IN WARM WATERS
- METALITE FABRIC INSIDE
- THE PERFECT CHOICE FOR SWIMMING POOLS OR SNORKELING
- JUNIOR SIZES WITH DEDICATED GRAPHICS AVAILABLE

THERMO GUARD

LONG SLEEVE

code: 412550 Man

code: 412554 She Dives

SHORT SLEEVE

code: 412549 Man

code: 412553 She Dives

SHORTS

code: 412534 Man

code: 412535 She Dives

- BODY CORE COMFORT FOR ALL WATER SPORTS
- EASY TO WEAR AND SMOOTH ON YOUR SKIN
- METALITE COATING HELPS RETAIN HEAT FOR SUPERIOR WARMTH
- FLAT STITCHING FOR COMFORTABLE CONTACT WITH YOUR BODY



UPF 50+

TECHNICAL FEATURES

Thickness	1.5 mm								
Fabric type	Neoprene / Metalite inside								
Sizes Man (BL)				2	3	4	5	6	7
Sizes She Dives (AQ)			1	2	3	4	5		
Sizes Junior (YL)	-3	-2	-1	0					

UPF 50+

TECHNICAL FEATURES

Thickness	0,5 mm							
Fabric type	Neoprene / Metalite inside							
Sizes Man		XS	S	M	L	XL	2XL	3XL
Sizes She Dives	XXS	XS	S	M	L	XL	2XL	

RASH GUARD UPF BLOCK 80+ **NEW**

code: 412413 Man BL

code: 412414 She Dives LIL

code: 412415 Junior YL

- LONG-SLEEVED RASH GUARD UPF BLOCK 80+ AVAILABLE IN A MAN'S, WOMAN'S AND JUNIOR VERSION WITH DEDICATED CUT
- FOR ALL KINDS OF WATERSPORTS
- COOL, LIGHTWEIGHT MATERIAL
- FAST DRYING
- FLAT SEAM CONSTRUCTION FOR COMFORT

FIRESKIN*

LONG SLEEVE

code: 412335 Man

code: 412336 She Dives

LONG SLEEVE WITH HOOD

code: 412847 Man

code: 412848 She Dives

SHORT SLEEVE

code: 412849 Man

code: 412850 She Dives

- THE NEW INNOVATIVE UNDER SUIT
- THERMODYNAMIC PROPERTIES
- REGULATES BODY HEAT AND GUARANTEES THE BEST THERMAL PROTECTION
- FIRE SKIN TEXTILE IS INFUSED WITH GRAPHITE PRODUCING INFRARED HEATING WHEN THE GARMENT IS IN DIRECT CONTACT WITH THE SKIN
- ANTIBACTERIAL, ANTI-ODOR, CHEMICAL FREE AND ANTISTATIC
- FIRE SKIN WON'T LOSE ANY PROPERTIES BY WASHING IT, SINCE IT'S A SPECIAL FIBER AND NOT A COATING
- SUITABLE AS AN UNDER SUIT FOR WETSUITS AND DRYSUITS

*Until stock lasts



UPF 80+

TECHNICAL FEATURES

Thickness	-							
Fabric type	Nylon / Spandex							
Sizes Man		XS	S	M	L	XL	2XL	3XL
Sizes She Dives	XXS	XS	S	M	L	XL	2XL	
Sizes Junior			S	M	L	XL		

TECHNICAL FEATURES

Thickness	-							
Fabric type	Graphite Fabric							
Sizes Man		XS	S	M	L	XL	2XL	3XL
Sizes She Dives	XXS	XS	S	M	L			

RASH GUARD

LONG SLEEVE

code: 412551 Man

code: 412555 She Dives

SHORT SLEEVE

code: 412552 Man

code: 412556 She Dives

SHORTS

code: 412547 Man

code: 412548 She Dives

- FOR ALL KINDS OF WATER SPORTS
- COOL, LIGHTWEIGHT MATERIAL
- FAST DRYING
- FLAT SEAM CONSTRUCTION FOR COMFORT



RASH GUARD LOOSE FIT

LONG SLEEVE

code: 412539 LM Man / 412539 BL Man

code: 412541 LIL She Dives / 412541 AQ She Dives

SHORT SLEEVE

code: 412540 LM Man / 412540 BL Man

code: 412542 LIL She Dives / 412542 AQ She Dives

- BE COOL AND PROTECTED
- LOOSE FIT STYLE
- NEW VIBRANT COLORS
- FAST DRYING
- IDEAL AS AN UNDERGARMENT OR BY ITSELF
- FLAT SEAM CONSTRUCTION FOR COMFORT



UPF 50+

TECHNICAL FEATURES

Thickness	-							
Fabric type	Polyester / Spandex							
Sizes Man		XS	S	M	L	XL	2XL	3XL
Sizes She Dives	XXS	XS	S	M	L	XL	2XL	

UPF 30+

TECHNICAL FEATURES

Thickness	-							
Fabric type	Nylon / Spandex							
Sizes Man		XS	S	M	L	XL	2XL	3XL
Sizes She Dives	XXS	XS	S	M	L	XL	2XL	

RASH GUARD KID

BOY

code: 412543 Long Sleeve

code: 412559 Short Sleeve

GIRL

code : 412544 Long Sleeve

code: 412560 Short Sleeve

- FOR ALL KINDS OF WATER SPORTS
- COOL, LIGHTWEIGHT MATERIAL
- FAST DRYING
- FLAT SEAM CONSTRUCTION FOR COMFORT
- DEDICATED KID CUT



RASH GUARD JUNIOR

BOY

code: 412500 Long Sleeve

code: 412506 Short Sleeve

GIRL

code: 412501 Long Sleeve

code: 412507 Short Sleeve

- FOR ALL KINDS OF WATER SPORTS
- COOL, LIGHTWEIGHT MATERIAL
- FAST DRYING
- FLAT SEAM CONSTRUCTION FOR COMFORT
- DEDICATED JUNIOR CUT



UPF 50+

TECHNICAL FEATURES

Thickness	-				
Fabric type	Polyester / Spandex				
Sizes	XS	S	M	L	XL
Ages*	2/3	3/4	4/5	5/6	6/7

*Ages indicated in the table are purely for reference

UPF 50+

TECHNICAL FEATURES

Thickness	-				
Fabric type	Polyester / Spandex				
Sizes	XS	S	M	L	XL
Ages*	8/9	9/10	10/11	11/12	12/13

*Ages indicated in the table are purely for reference

TRILASTIC STEAMER

code: 412545 Man

code: 412546 She Dives

- SNORKELING WITHOUT WORRIES
- PROTECTS ALMOST YOUR ENTIRE BODY SURFACE FROM SOLAR RAYS OR OCCASIONAL SEA ENCOUNTERERS
- CAN BE USED AS THE PERFECT LAYER UNDER A RENTAL SUIT
- STIRRUPS EQUIPPED FOR SECURE PLACEMENT



PHOTOSUIT

NEW

code: 412525

- IDEAL FOR PHOTOGRAPHERS
- TO BE WORN OVER A WETSUIT
- 4 COLORS AVAILABLE



YL



RD

BL

WH

UPF 50+

TECHNICAL FEATURES

Thickness	-							
Fabric type	Polyester / Spandex							
Sizes Man		XS	S	M	L	XL	2XL	3XL
Sizes She Dives	XXS	XS	S	M	L	XL	2XL	

UPF 50+

TECHNICAL FEATURES

Thickness	-		
Fabric type	Polyester / Spandex		
Sizes Unisex	2	3	4

HOODS

FLEXA

code: 412822

- HOOD WITH FAST AIR RELEASE AND EAR EQUALIZATION SYSTEM



TECH

code: 412820

- DEDICATED TO DRY SUITS
- PATENTED BUILT-IN VALVE ALLOWING TRAPPED AIR TO ESCAPE WITHOUT LETTING WATER IN
- REFLECTIVE TAPS FOR MORE VISIBILITY ON THE SURFACE
- DEVELOPED IN COOPERATION WITH MOBBY'S



TECHNICAL FEATURES

Thickness	6-4-3 mm				
Size	XS	S	M	L	XL

TECHNICAL FEATURES

Thickness	6-5-3 mm					
Size	XS	S	M	L	XL	XXL

ACCESSORIES

NEOPRENE GLUE

code: 415108

- IDEAL FOR URGENT AND QUICK WETSUIT REPAIRS
- MADE IN COMPLIANCE WITH LATEST REGULATIONS
- 20ml



TIZIP LUBRICANT STICK

code: 415728

- FOR SEMI-DRY TIZIP
- TO PREVENT DRYING
- TO INCREASE DURABILITY



MINERAL TALCUM

code: 415748 Desk Exhibitor (6pcs)

- HIGH QUALITY TALCUM TO PROTECT LATEX AND RUBBER PARTS
- IDEAL FOR MAINTENANCE AND THE CARE OF DRYSUITS AND WETSUITS
- MAKES DONNING SUITS EASIER
- PREVENTS IRRITATION
- 125 gr



BOOTS

FLEXA DS

code: 412626



TECHNICAL FEATURES

Thickness	5 mm									
Size	5	6	7	8	9	10	11	12	13	

code: 412628



TECHNICAL FEATURES

Thickness	6.5 mm									
Size	5	6	7	8	9	10	11			

CLASSIC NG

code: 412619



TECHNICAL FEATURES

Thickness	5 mm									
Size	3	4	5	6	7	8	9	10	11	12

EQUATOR

code: 412613



TECHNICAL FEATURES

Thickness	2 mm									
Size	4	5	6	7	8	9	10	11	12	

CLASSIC SOCK

code: 412611



TECHNICAL FEATURES

Thickness	3 mm					
Size	XXS	XS	S	M	L	XL

GLOVES

FLEXA FIT

code: 412718



TECHNICAL FEATURES

Thickness	5 mm					
Size	XXS	XS	S	M	L	XL

code: 412717



TECHNICAL FEATURES

Thickness	6.5 mm					
Size	XXS	XS	S	M	L	XL

FLEXA TOUCH

code: 412721



TECHNICAL FEATURES

Thickness	2 mm		
Size	XS/S	M/L	XL/XXL

FLEXA CLASSIC

code: 412719



TECHNICAL FEATURES

Thickness	3 mm					
Size	XXS	XS	S	M	L	XL

AMARA

code: 412702



TECHNICAL FEATURES

Thickness	2 mm					
Size	XXS	XS	S	M	L	XL

TECHNICAL SPECIFICATIONS



Suit	Seal Skin		Flexa Therm		Flexa					
Model	Man	She Dives	Man	She Dives	Man	She Dives	Man	She Dives	Man	She Dives
Code	412369	412370	412069	412070	412337	412339	412338	412340	412348	412349
Thickness	6		6,5		8 - 6 - 5		5 - 4 - 3		3 - 2 - 2	
Sizes	2-3-4-5-6-7	1-2-3-4-5	2-3-4-5-6-7	1-2-3-4-5	2-3-4-5-6-7	1-2-3-4-5	2-3-4-5-6-7	1-2-3-4-5	2-3-4-5-6-7	1-2-3-4-5
FOR COLD WATER	■		■		■					
FOR TEMPERATE WATER							■			
FOR WARM WATER									■	
BACK PROTECTION SYSTEM					■		■		■	
INSTRUMENTS GRIP	■				■		■		■	
MASTERSEAL ZIP			■							
G-LOCK ZIPPER:										
S-LOCK ZIPPER	■									
ZIPPERS ON ANKLES	■		■							
DOUBLE CONE	■		■							
THERMO PLUSH			■		■		■		■	
HOOD INCLUDED	■		■							
HOOD KEEPER	■		■		■		■		■	
FLEXA SMART POCKET	■				■		■		■	



Suit	Pioneer				Dual		Reef		Coral		Scuba Ranger	
Model	Man	She Dives	Man	She Dives	Man	She Dives	Man	She Dives	Man	She Dives	Jacket	LongJohn
Code	412346	412347	412344	412345	412375	412376	412382	412383	412386	412387	412373	412374
Thickness	7		5		5		3		0,5		5	
Sizes	2-3-4-5-6-7	1-2-3-4-5	2-3-4-5-6-7	1-2-3-4-5	2-3-4-5-6-7	1-2-3-4-5	2-3-4-5-6-7	1-2-3-4-5	2-3-4-5-6-7	1-2-3-4-5	-3--2--1-0	
FOR COLD WATER	■										■	
FOR TEMPERATE WATER			■		■						■	
FOR WARM WATER							■		■		■	
INSTRUMENTS GRIP	■		■		■							
ZIPPERS ON ANKLES	■										■	
DOUBLE CONE	■											
HOOD INCLUDED	■		■									
HOOD KEEPER	■		■									

SIZE CHART

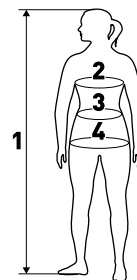
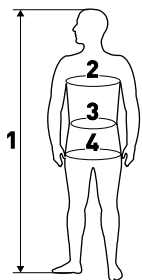

WETSUIT ≥ 5mm

IT	2	3	4	5	6	7	8
EU	S	M	L	XL	XXL	3XL	4XL
USA		S	M	L	XL	XXL	XXXL
1	175 / 59"	178 / 510"	181 / 511"	184 / 6'	187 / 62"	190 / 63"	193 / 64"
2	93 / 37"	97,5 / 38"	101,5 / 40"	105,5 / 42"	110 / 43"	114 / 45"	118 / 46"
3	73 / 29"	77,5 / 31"	81,5 / 32"	86 / 34"	90 / 35"	94 / 37"	98 / 39"
4	91 / 36"	95,5 / 38"	99,5 / 39"	104 / 41"	108 / 43"	112 / 44"	116 / 46"

IT	1	2	3	4	5	6	7
EU	XS	S	M	L	XL	XXL	3XL
USA	4	6	8	10	12	14	16
1	164 / 55"	167 / 56"	170 / 57"	173 / 58"	176 / 59"	179 / 510"	182 / 6'
2	77,5 / 31"	81,5 / 32"	85,5 / 34"	89,5 / 35"	93,5 / 37"	97,5 / 38"	101,5 / 40"
3	67 / 26"	71 / 28"	75 / 30"	79 / 31"	83 / 33"	87 / 34"	91 / 36"
4	84 / 33"	88 / 35"	92 / 36"	96 / 38"	100 / 39"	104 / 41"	108 / 43"

WETSUIT ≤ 3mm

IT	2	3	4	5	6	7	8
EU	S	M	L	XL	XXL	3XL	4XL
USA		S	M	L	XL	XXL	XXXL
1	176 / 59"	179 / 510"	182 / 6'	185 / 61"	188 / 62"	191 / 63"	194 / 64"
2	92 / 36"	96,5 / 38"	100,5 / 40"	105 / 41"	109 / 43"	113,5 / 45"	117,5 / 46"
3	71,5 / 28"	75,5 / 30"	80 / 32"	84 / 33"	88,5 / 35"	92,5 / 36"	97 / 38"
4	91 / 36"	95 / 37"	99,5 / 39"	103,5 / 41"	108 / 43"	112 / 44"	116 / 46"

IT	1	2	3	4	5	6	7
EU	XS	S	M	L	XL	XXL	3XL
USA	4	6	8	10	12	14	16
1	163,5 / 54"	166,5 / 56"	169,5 / 57"	172,5 / 58"	175,5 / 59"	178,5 / 510"	181,5 / 511"
2	75 / 30"	79 / 31"	83 / 33"	87 / 34"	91 / 36"	95 / 37"	99 / 39"
3	66 / 26"	70 / 28"	74 / 29"	78 / 31"	82 / 32"	86 / 34"	90 / 35"
4	82,5 / 32"	86,5 / 34"	90,5 / 36"	94,5 / 37"	98,5 / 39"	102,5 / 40"	106,5 / 42"

THERMO GUARD SHORTY UNISEX

IT	EU	CHEST	WAIST	HIPS	TOLERANCE
-3	8 A	56 / 22"	52 / 20"	66 / 26"	± 2 / ± 0.8"
-2	10 A	61 / 24"	56 / 22"	75 / 30"	± 2 / ± 0.8"
-1	12 A	67 / 26"	60 / 24"	79 / 31"	± 2 / ± 0.8"
0	14 A	73 / 29"	65 / 26"	87 / 34"	± 2 / ± 0.8"
1	XS	86 / 34"	65 / 26"	85 / 33"	± 2 / ± 0.8"
2	S	90 / 35"	70 / 28"	89 / 35"	± 2 / ± 0.8"
3	M	94 / 37"	74 / 29"	94 / 37"	± 2 / ± 0.8"
4	L	99 / 39"	78 / 31"	98 / 39"	± 2 / ± 0.8"
5	XL	103 / 41"	82 / 32"	102 / 40"	± 2 / ± 0.8"
6	XXL	107 / 42"	86 / 34"	106 / 42"	± 2 / ± 0.8"
7	3XL	111 / 44"	91 / 36"	111 / 44"	± 2 / ± 0.8"

NEOPRENE BOOTS

	EUROPE	USA	JAPAN
3XS	35/36	4	-
2XS	36/37	5	23 cm
XS	38	6	24 cm
S	39/40	7	25 cm
M	40/41	8	26 cm
L	41/42	9	27 cm
XL	43	10	28 cm
2XL	44/45	11	29 cm
3XL	45/46	12	-
4XL	47	13	-



maiares EXTRA

FINS

EXCITE / EXCITE PRO

NEW

code: 410025 EXCITE

code: 410026 EXCITE PRO



- INNOVATIVE MATERIALS FOR A MORE HARMONIOUS THRUST
- ENHANCED CHANNEL THRUST
- EXCITE: OPTIMIZED FOR LOW FATIGUE
- EXCITE PRO: OPTIMIZED FOR MAXIMUM THRUST
- COLOR COORDINATED BUNGEE STRAP

COLOR VARIATIONS EXCITE



YL

BL

COLOR VARIATIONS EXCITE PRO



GR

TECHNICAL FEATURES

Sizes	XS	S	R	XL
Fit	34/37	37/41	41/44	44/48
Blade*	36 cm / 14.1 in	39 cm / 15.3 in	40 cm / 15.7 in	40 cm / 15.7 in

* From end of footpocket to end of blade

X-STREAM

code: 410019**

- ABS PLUS BUCKLES AND PERFORATED PULL TAB
- RIDDLED FOOT POCKET AVOIDS "PARACHUTE EFFECT"
- NEXT GENERATION OPB
- TRI-MATERIAL BLADE CONSTRUCTION REDUCES TURBULENCE
- CHANNEL THRUST TECHNOLOGY



reddot design award



AVANTI EXCEL

code: 410316**

- ANATOMICAL FOOT POCKET
- WHALE TAIL DESIGN FOR POWERFUL FOOT-BLADE POWER TRANSMISSION
- TRI-MATERIAL BLADE WITH CHANNEL THRUST TECHNOLOGY



COLOR VARIATIONS



YL BL RD TBK WH JPK

TECHNICAL FEATURES

Sizes	XS	S	R	XL
Fit	34/37	37/41	41/44	44/48
Blade*	34,5 cm / 13.6 in	36 cm / 14.2 in	37 cm / 14.6 in	38 cm / 15 in

* From end of footpocket to end of blade

** Please note that some sizes/colors are only available while stocks last

COLOR VARIATIONS



YL BL SI

TECHNICAL FEATURES

Sizes	34/35	36/37	38/39	40/41	42/43	44/45	46/47
Blade*	29,5 cm / 11.6 in	30 cm / 11.8 in	31 cm / 12.2 in	32 cm / 12.6 in	33 cm / 13 in	34 cm / 13.4 in	35,5 cm / 14 in

* From end of footpocket to end of blade

** Please note that some sizes/colors are only available while stocks last

VOLO POWER

code: 410008

- ABS PLUS BUCKLES
- OPB SYSTEM FOR GREAT KICKING EFFICIENCY
- CHANNEL THRUST TECHNOLOGY



VOLO RACE

code: 410313

- ANATOMICAL FOOT POCKET
- OPB SYSTEM FOR EASY KICKING EFFICIENCY
- CHANNEL THRUST TECHNOLOGY



COLOR VARIATIONS



YL

BL

SI

TECHNICAL FEATURES

Sizes	S	R	XL
Fit	37/41	41/44	44/48
Blade*	36 cm / 14.2 in	37 cm / 14.6 in	37 cm / 14.6 in

* From end of footpocket to end of blade

COLOR VARIATIONS



YL

BL

BGR

TECHNICAL FEATURES

Sizes	36/37	38/39	40/41	42/43	44/45	46/47
Blade*	33,5 cm 13.2 in	33,5 cm 13.2 in	36,5 cm 14.5 in	37 cm 14.6 in	39,5 cm 15.6 in	39,5 cm 15.6 in

* From end of footpocket to end of blade

AVANTI QUATTRO +

code: 410003**

- BUNGEE STRAP
- HI-FLEX MATERIAL OPTIMIZES BLADE'S EFFICIENCY
- 4 CHANNELS FOR GREATER THRUSTING POWER
- STABILIZING TRIM TABS



COLOR VARIATIONS



YL

BL

BK

WH

LM

FL

TECHNICAL FEATURES

Sizes	S	R	XL
Fit	37/41	41/44	44/48
Blade*	37 cm / 14.6 in	38 cm / 15 in	39 cm / 15.3 in

* From end of footpocket to end of blade

** Please note that some sizes/colors are only available while stocks last

AVANTI QUATTRO POWER

code: 410301**

- ANATOMICAL FOOT POCKET
- RUBBERIZED SIDE RIBS
- 4 CHANNELS FOR GREATER THRUSTING POWER
- LONG BLADE, IDEAL FOR BOTH SCUBA AND APNEA



COLOR VARIATIONS



YL

BL

BK

TECHNICAL FEATURES

Sizes	40/41	42/43	44/45
Blade*	44 cm 17.3 in	45,5 cm 17.9 in	45,5 cm 17.9 in

* From end of footpocket to end of blade

** Please note that some sizes/colors are only available while stocks last

WAVE

code: 410017**

- ABS PLUS BUCKLES
- ANATOMICAL FOOT POCKET
- TRI-MATERIAL CONSTRUCTION
- HUGE SUPERCHANNEL PRODUCES GREAT THRUST



WAVE FF

code: 410332**

- ANATOMICAL FOOT POCKET
- TRI-MATERIAL CONSTRUCTION
- HUGE CHANNEL, GREAT THRUST



COLOR VARIATIONS

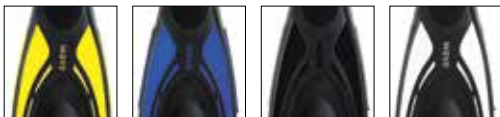

BYL BBL BBK BWH

TECHNICAL FEATURES

Sizes	XS	S	R	XL
Fit	34/37	37/41	41/44	44/48
Blade*	36 cm / 14.1 in	37 cm / 14.6 in	39 cm / 15.3 in	39,5 cm / 15.6 in

* From end of footpocket to end of blade

** Please note that some sizes/colors are only available while stocks last

COLOR VARIATIONS



BYL BBL BBK

TECHNICAL FEATURES

Sizes	36/37	38/39	40/41	42/43	44/45	46/47
Blade*	34,5 cm 13.6 in	35 cm 13.8 in	35,5 cm 14 in	36 cm 14.2 in	36,5 cm 14.4 in	37,5 cm 14.8 in

* From end of footpocket to end of blade

** Please note that some sizes/colors are only available while stocks last

AVANTI SUPERCHANNEL OH

code: 410012

- STANDARD BUNGEE STRAP
- ANATOMICAL OPEN HEEL FOOT POCKET
- 3 CHANNEL DESIGN FOR ADDED PROPULSION
- RUGGED AND DURABLE CONSTRUCTION



COLOR VARIATIONS



YL

BL

BK

TECHNICAL FEATURES

Sizes	S	R	XL
Fit	37/41	41/44	44/48
Blade*	35 cm / 13.8 in	37 cm / 14.6 in	37 cm / 14.6 in

* From end of footpocket to end of blade

AVANTI SUPERCHANNEL FF

code: 410317

- ORTHOPEDIC FOOT POCKET
- TECRALENE BLADE FOR SUPERIOR PERFORMANCE AND DURABILITY
- 3 CHANNEL DESIGN FOR ADDED PROPULSION



COLOR VARIATIONS



YL

BL

RD

WH

TECHNICAL FEATURES

Sizes	36/37	38/39	40/41	42/43	44/45	46/47
Blade*	32 cm 12.6 in	33 cm 13 in	34 cm 13.4 in	35,5 cm 14 in	36,5 cm 14.5 in	37 cm 14.6 in

* From end of footpocket to end of blade

AVANTI TRE

code: 410302

- ORTHOPEDIC FOOT POCKET
- 3 CHANNELS FOR MAXIMUM THRUST
- MID-SIZE BLADE WITH DURABLE CONSTRUCTION
- STABILIZING TRIM TABS



POWER PLANA

code: 410007

- BUNGEE STRAP
- FULL SHAPE FOOT POCKET
- MADE IN NATURAL RUBBER
- NEGATIVE BUOYANCY



COLOR VARIATIONS



YL

BL

BK

TECHNICAL FEATURES

Sizes	36/37	38/39	40/41	42/43	44/45	46/47
Blade*	31 cm 12.2 in	33 cm 13 in	34 cm 13.4 in	36 cm 14.2 in	36,5 cm 14.5 in	37,5 cm 14.8 in

* From end of footpocket to end of blade

TECHNICAL FEATURES

Sizes	S	R	XL	XXL
Fit	37/41	41/44	44/48	44/50**
Blade*	29 cm / 11.4in	29 cm / 11.4in	29,5 cm / 11.6 in	29,5 cm / 11.6 in

** Thick-soled (Rock Boots)
* From end of footpocket to end of blade

ACCESSORIES

BUNGEE STRAP

NEW

code: 415363 (PAIR)

- SMART ALTERNATIVE TO STEEL SPRING STRAPS
- 3 SIZES: XS/S - R - XL
- 5 COLOR OPTIONS: BK-WH-BL-YL-LM
- 2 EXTENSIONS FOR A BETTER FIT
- ERGONOMIC HEEL COVER
- WIDE LOOP TO BE USED EVEN WITH THICK GLOVES



BK



WH



BL



YL



LM

ABS PLUS BUCKLE

code: 415337 (PAIR)

- USER FRIENDLY BUCKLE SYSTEM
- EASY DONNING AND DOFFING WITH THICK GLOVES
- CAN BE MOUNTED ON ALL MARES OPEN HEEL FIN



FIN STRAP

code: 415120

- UNIVERSAL FIN STRAP FOR OPEN HEEL FIN
- WIDTH: 30 mm/1.2 in - LENGTH: 460 mm/18.1 in
- HIGH QUALITY VULCANIZED RUBBER MATERIAL



TECHNICAL SPECIFICATIONS



Fins	Excite Pro	Excite	X-stream	Avanti Excel	Volo Power	Volo Race	Avanti Quattro +	Avanti Quattro Power	Wave	Wave FF	Avanti Superchannel OH	Avanti Superchannel FF	Avanti Tre	Power Plana	
Code	410026	410025	410019**	410316**	410008	410313	410003**	410301**	410017**	410332**	410012	410317	410302	410007	
Sizes	XS · S · R · XL	XS · S · R · XL	XS · S · R · XL	34/35 36/37 38/39 40/41 42/43 44/45 46/47	S · R · XL	36/37 38/39 40/41 42/43 44/45 46/47	S · R · XL	40/41 42/43 44/45	XS · S · R · XL	36/37 38/39 40/41 42/43 44/45 46/47	S · R · XL	36/37 38/39 40/41 42/43 44/45 46/47	36/37 38/39 40/41 42/43 44/45 46/47	S · R · XL · XXL	
Colors	■ GR	■ YL ■ BL	■ YL ■ BL ■ RD ■ TBK ■ WH ■ JPK	■ YL ■ BL ■ SI	■ YL ■ BL ■ SI	■ YL ■ BL ■ BGR	■ YL ■ BL ■ BK ■ WH ■ LM ■ FL	■ YL ■ BL ■ BK	■ BYL ■ BBL ■ BBK ■ BWH	■ BYL ■ BBL ■ BBK	■ YL ■ BL ■ BK	■ YL ■ BL ■ RD ■ WH	■ YL ■ BL ■ BK	■ BK	
OPB · Optimized Pivoting Blade	■	■	■	■	■	■	■	■	■	■	■	■	■	■	
CHANNEL THRUST	■	■	■	■	■	■	■	■	■	■	■	■	■	■	
TRI-MATERIAL CONSTRUCTION			■	■											
Thermoplastic rubber/Technopolymers	■	■	■	■	■	■	■	■	■	■					
Thermoplastic rubber/Tecralene							■	■			■	■	■		
Natural rubber														■	
Blade*: Open heel (size R) Full foot (size 42/43)	Length	cm	40	37	33	37	37	38	45,5	39	36	37	35,5	36	27,5
		in	15,7	14,6	13	14,6	14,6	15	17,9	15,3	14,2	14,6	14	14,2	10,8
	Thrust Area	cm²	800	750	560	700	680	780	960	780	650	730	650	680	600
		in²	124,0	116,3	86,8	108,5	105,4	120,9	148,8	120,9	100,7	113,1	100,7	105,4	93
Weight one fin without buckles (size R or 42/43)	Kg	0,9	0,7	0,6	0,7	0,7	0,9	1	0,8	0,6	0,9	0,7	0,6	1,3	
	lb	2	1,5	1,3	1,5	1,5	2	2,2	1,8	1,3	2	1,5	1,3	2,9	

* From end of footpocket to end of blade

** Please note that some sizes/colors are only available while stocks last



MASKS & SNORKELS

X-VISION ULTRA

code: 411052

- ULTRA CLEAR SKIRT (CLYLWCYL, CLBLWCBL)
- MIRRORED GOLD LENS INCREASES VISIBILITY IN CLOUDY WATERS (GOGRKGRK)
- MIRRORED SILVER LENS REDUCES THE REFLECTION OF SHALLOW WATER OR SANDY SEABED (SIGRKGRK)
- NEW BI-SILICONE SKIRT CONTOURED FOR ENHANCED FIT AND COMFORT
- LOW DRAG DESIGN
- SMALL RIBS AROUND NOSE TO RELIEVE PRESSURE
- FIELD OF VISION 20% WIDER THAN PREVIOUS VERSION
- X-SHAPED BI-SILICONE STRAP



reddot design award



COLOR VARIATIONS



CLWHKWHK

CLRDKRDK

CLGRKGRK

CLYLKYLK



CLYLWCYL

CLBLWCBL

CLBLWBLW

CLPKWPKW

TECHNICAL FEATURES

Weight [g]	183
Optical lens	
	-1,0 / -1,5 / -2,0 / -2,5 / -3,0 / -3,5 / -4,0 / -4,5 / -5,0 / -5,5 / -6,0 / -6,5 / -7,0
	+1,5 / +2,0 / +2,5 / +3,0
code:	411194

COLOR VARIATIONS MIRRORED



SIGRKGRK

GOGRKGRK

MIRRORED SILVER COATING

Reduces the diffuse reflection of shallow waters and sandy seabeds.

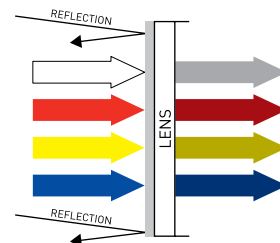

MIRRORED GOLD COATING

Reduces the dominant blue color and increases contrast and visibility.

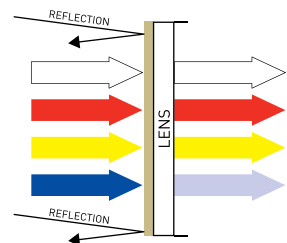

BUCKLE

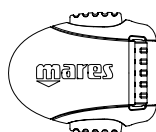

MIRRORED LENSES

Mirrrored lenses do not hide the user's eyes, ensuring visual contact when diving.

X-VU LiquidSkin

code: 411033*

code: 411041 Sunrise*

- BI-SILICONE SKIRT FOR UNMATCHED COMFORT
- SMALL RIBS AROUND NOSE TO RELIEVE PRESSURE
- X-SHAPED BI-SILICONE STRAP
- OPTICAL LENSES AVAILABLE
- SUNRISE VERSION AVAILABLE



ESSENCE LiquidSkin

code: 411031

- BI-SILICONE SKIRT FOR UNMATCHED COMFORT
- LIGHT AND FOLDABLE, ALSO IDEAL AS SPARE MASK
- AMPLE FIELD OF VISION
- X-SHAPED BI-SILICONE STRAP
- SINGLE LENS DESIGN



COLOR VARIATIONS



CYLYL CBLBL CRDRD SBK BK WBLWH WPKWH WBKWH SIHWH

sunrise



WRDWH GBKGR WBLWH WPKWH SWHWH WLBW

TECHNICAL FEATURES

Weight (g)	173
Optical lens	
-1,0 / -1,5 / -2,0 / -2,5 / -3,0 / -3,5 / -4,0 / -4,5 / -5,0 / -5,5 / -6,0 / -6,5** / -7,0**	
+1,5 / +2,0 / +2,5 / +3,0	
code: 411192	

BUCKLE

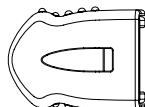

COLOR VARIATIONS



CLBL BKGR CLWH

TECHNICAL FEATURES

Weight (g)	185
------------	-----

BUCKLE



* Please note that some colors are only available while stocks last
 ** Until stock lasts

X-FREE

NEW

code: 411060

- OVERMOLDED FRAME AND ANATOMICAL SILICONE SKIRT
- MINIMUM DISTANCE BETWEEN LENS AND EYES
- AMPLE FIELD OF VISION
- LIGHTWEIGHT
- ERGONOMIC MASK STRAP BUCKLES FOR EASY OPERATION
- EMBOSSED GRIP AREA ON THE NOSE FOR PERFECT FIT WITH A NOSE CLIP



I3

code: 411040

code: 411042 Sunrise

- SILICONE SKIRT
- SMALL RIBS AROUND NOSE TO RELIEVE PRESSURE
- GREAT PERIPHERAL VISION
- X-SHAPED SILICONE STRAP
- SUNRISE VERSION AVAILABLE



COLOR VARIATIONS



WHBK

LMBK

YLBK

BLWH

PKWH

TECHNICAL FEATURES

Weight (g)	147
------------	-----

COLOR VARIATIONS

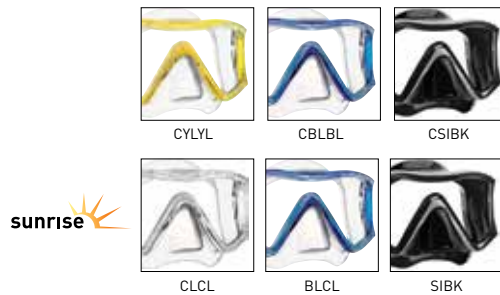

CYLYL

CBLBL

CSIBK

sunrise

CLCL

BLCL

SIBK

TECHNICAL FEATURES

Weight (g)	210
------------	-----

BUCKLE



BUCKLE

REGULAR

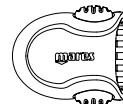

SUNRISE



JUNO

NEW

code: 411056

- FRAMELESS MONOLENS MASK
- SILICONE SKIRT
- SAME STYLE AS THE JUPITER BUT WITH A REGULAR SKIRT FIT
- PIVOTING BUCKLE ON SKIRT
- GREAT FIELD OF VISION



COLOR VARIATIONS



TECHNICAL FEATURES

Weight (g)	192
------------	-----

BUCKLE

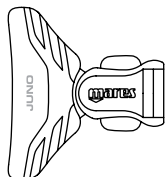

JUPITER

NEW

code: 411057

- FRAMELESS MONOLENS MASK
- SILICONE SKIRT
- SAME STYLE AS THE JUNO BUT WITH AN "XL" SKIRT FIT FOR BIGGER FACES
- PIVOTING BUCKLE ON SKIRT
- GREAT FIELD OF VISION



COLOR VARIATIONS

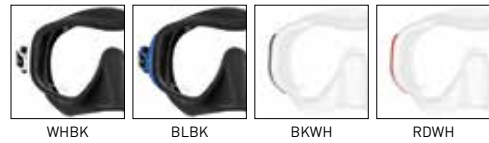

TECHNICAL FEATURES

Weight (g)	194
------------	-----

BUCKLE

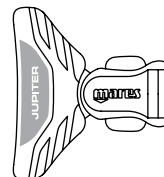

SEALHOUETTE

NEW

code: 411058

- BI-LENS MASK
- SILICONE SKIRT
- REDUCED DISTANCE BETWEEN LENSES AND EYES
- AMPLE FIELD OF VISION
- LIGHTWEIGHT
- SOFT SILICONE BUCKLES
- BUCKLES ON SKIRT



COLOR VARIATIONS

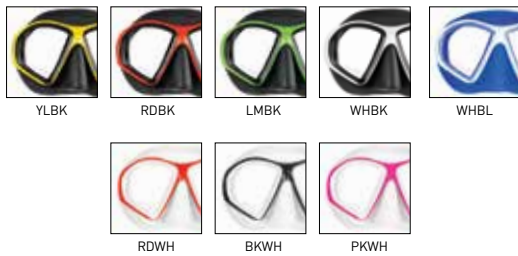

TECHNICAL FEATURES

Weight (g)	161
------------	-----

BUCKLE



COMET

NEW

code: 411059

- MONOLENS MASK FOR CHILDREN
- SILICONE SKIRT
- AMPLE FIELD OF VISION
- LIGHTWEIGHT
- COMFORTABLE DETACHABLE BUCKLES



COLOR VARIATIONS

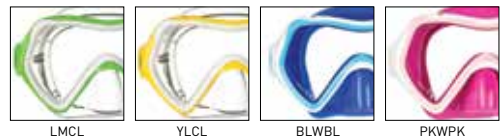

TECHNICAL FEATURES

Weight (g)	174
------------	-----

BUCKLE

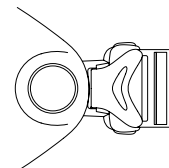

X-VU

code: 411036

- SILICONE SKIRT
- SMALL RIBS AROUND NOSE TO RELIEVE PRESSURE
- X-SHAPED SILICONE STRAP
- OPTICAL LENSES AVAILABLE



COLOR VARIATIONS

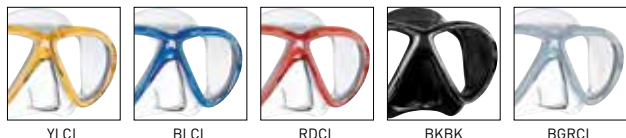

TECHNICAL FEATURES

Weight (g)	174
Optical lens	-1,0 / -1,5 / -2,0 / -2,5 / -3,0 / -3,5 / -4,0 / -4,5 / -5,0 / -5,5 / -6,0 / -6,5* / -7,0* +1,5 / +2,0 / +2,5 / +3,0
code:	411192

BUCKLE

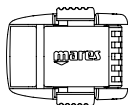

* Until stock lasts

X-VISION

code: 411053

- ULTRA CLEAR SILICONE
- LOW DRAG DESIGN
- SMALL RIBS AROUND NOSE TO RELIEVE PRESSURE
- FIELD OF VISION 20% WIDER THAN PREVIOUS VERSION
- X-SHAPED SILICONE STRAP
- OPTICAL LENSES AVAILABLE



COLOR VARIATIONS

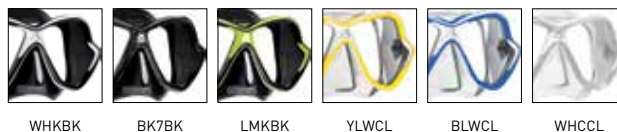

TECHNICAL FEATURES

Weight (g)	189
Optical lens	-1,0 / -1,5 / -2,0 / -2,5 / -3,0 / -3,5 / -4,0 / -4,5 / -5,0 / -5,5 / -6,0 / -6,5 / -7,0 +1,5 / +2,0 / +2,5 / +3,0
code:	411194

BUCKLE

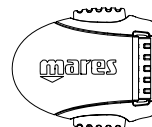

X-VISION MID

code: 411024

- SILICONE SKIRT
- MEDIUM SIZED
- WIDE VIEWING ANGLE
- X-SHAPED SILICONE STRAP
- OPTICAL LENSES AVAILABLE



COLOR VARIATIONS



TECHNICAL FEATURES

Weight (g)	189
Optical lens	
-1,0 / -1,5 / -2,0 / -2,5 / -3,0 / -3,5 / -4,0 / -4,5 / -5,0 / -5,5 / -6,0 / -6,5* / -7,0*	
code: 411187	
+1,5 / +2,0 / +2,5 / +3,0	
code: 411186	

BUCKLE

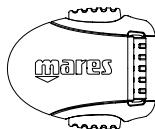

* Until stock lasts

ONE VISION

code: 411046

code: 411047 Sunrise

- SILICONE SKIRT
- LOW DRAG DESIGN
- SMALL RIBS AROUND NOSE TO RELIEVE PRESSURE
- SINGLE LENS DESIGN
- X-SHAPED SILICONE STRAP
- SUNRISE VERSION AVAILABLE



COLOR VARIATIONS



sunrise 



TECHNICAL FEATURES

Weight (g)	200
------------	-----

BUCKLE

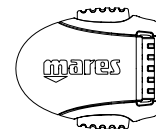

* Only available in some countries via drop shipment

OPERA

code: 411019

- SILICONE SKIRT
- STURDY AND DURABLE CONSTRUCTION
- OVAL SHAPED SILICONE STRAP
- OPTICAL LENSES AVAILABLE



COLOR VARIATIONS



RYLCL

RBLCL

TBKBK

TECHNICAL FEATURES

Weight (g)	184
Optical lens	
-1,0 / -1,5 / -2,0 / -2,5 / -3,0 / -3,5 / -4,0 / -4,5 / -5,0 / -5,5 / -6,0 / -6,5* / -7,0*	
code: 411182	

BUCKLE

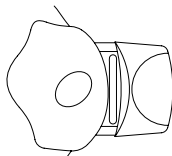

* Until stock lasts

TANA

code: 411055

- SILICONE SKIRT
- SOFT TOUCH INSERTS ON THE FRAME FOR GRIP
- LIGHTWEIGHT
- SIDE GUSSETS AT THE NOSE TO FACILITATE EQUALIZING



COLOR VARIATIONS



YLKCL

BLKCL

RDKBK

PKWWH

PUWWH

BLWCL

LBWWH

TECHNICAL FEATURES

Weight (g)	155
------------	-----

BUCKLE



TECHNICAL SPECIFICATIONS



Mask	X-vision Ultra <i>LiquidSkin</i>		X-vu <i>LiquidSkin</i>		Essence <i>LiquidSkin</i>	X- Free	i3		Juno	Jupiter
	Regular	Mirrored	Regular	sunrise			Regular	sunrise		
Code	411052	411052	411033*	411041*	411031	411060	411040	411042	411056	411057
Colors	<ul style="list-style-type: none"> CLWHKWHK CLRDKRDK CLGRKGRK CLYLKYLK CLYLWCYL CLBLWCBL CLBLWBLW CLPKWPKW 	<ul style="list-style-type: none"> SIGRKGRK GGRKGRK 	<ul style="list-style-type: none"> CYLYL CBLBL CRDRD SBKBK WBLWH WPKWH WBKWH SWHWH 	<ul style="list-style-type: none"> WRDWH GBKGR WBLWH WPKWH SWHWH WLBWH 	<ul style="list-style-type: none"> CLBL BKGR CLWH 	<ul style="list-style-type: none"> WHBK LMBK YLBK BLWH PKWH 	<ul style="list-style-type: none"> CYLYL CBLBL CSIBK 	<ul style="list-style-type: none"> CLCL BLCL SIBK 	<ul style="list-style-type: none"> WHBK RDBK LMBK WHBL RDWH BLWH WHCL PKCL 	<ul style="list-style-type: none"> WHBK BLBK BKWH RDWH
Weight [g]	183		173		185	147	210		192	194
LIQUIDSKIN	■		■		■					
SUNRISE			■				■			
MONOLENS					■		■		■	■
BILENS	■		■			■				
TRI-COMFORT	■		■				■			
OPTICAL LENSES	■		■							
Optical Lens (optionals)	Code 411194 from -1 to -7	NO	Code 411192 from -1 to -7,0*		NO	NO	NO		NO	NO
	Code 411194 from +1.5 to +3		Code 411192 from +1.5 to +3							



Mask	Sealhouette	Comet	X-vu	X-vision	X-vision Mid	One Vision		Opera	Tana
						Regular	sunrise		
Code	411058	411059	411036	411053	411024	411046	411047	411019	411055
Colors	<ul style="list-style-type: none"> YLBK RDBK LMBK WHBK WHBL RDWH BKWH PKWH 	<ul style="list-style-type: none"> LMCL YLCL BLWBL PKWPK 	<ul style="list-style-type: none"> YLCL BLCL RDCL BKBK BGRCL 	<ul style="list-style-type: none"> WHKKBK BK7BK LMKBK YLWCL BLWCL WHCCL 	<ul style="list-style-type: none"> CLCBL BKBK CLWLB CLBGR 	<ul style="list-style-type: none"> WHKKBK RDKBK BK7BK WSICL WYLCL WBLCL 	<ul style="list-style-type: none"> BK7BK** RDKBK WBLCL WSIWH** 	<ul style="list-style-type: none"> RYLCL RBLCL TBKBK 	<ul style="list-style-type: none"> YLKCL BLKCL RDKBK PKWWH PUWWH BLWCL LBWWH
Weight [g]	161	174	174	189	183	200		184	155
SUNRISE						■			
MONOLENS						■			
BILENS	■		■		■			■	■
TRI-COMFORT			■		■	■			
OPTICAL LENSES			■		■			■	
Optical Lens (optionals)	NO	NO	Code 411192 from -1 to -7,0*	Code 411194 from -1 to -7	Code 411187 from -1 to -7,0*	NO		Code 411182 from -1 to -7,0*	NO
			Code 411192 from +1.5 to +3	Code 411194 from +1.5 to +3	Code 411186 from +1.5 to +3			NO	

* Please note that some colors/sizes are only available while stocks last
 ** Only available in some countries via drop shipment

REBEL DRY

NEW

code: 411487

- 100% DRY TOP
- SLIDING SNORKEL KEEPER
- CORRUGATED SILICONE HOSE AND MOUTHPIECE
- EXHAUST VALVE
- SUITABLE FOR DIVING OR EXTENDED SNORKELING SESSIONS
- UNPARALLELED BREATHING COMFORT DUE TO THE INCREASED INTERNAL VOLUME OF THE BOTTOM HOUSING



COLOR VARIATIONS



REBEL SPLASH

NEW

code: 411488

- SEMIDRY TOP WITH ANTI SPLASH
- SLIDING SNORKEL KEEPER
- CORRUGATED SILICONE HOSE AND MOUTHPIECE
- EXHAUST VALVE
- SUITABLE FOR DIVING OR EXTENDED SNORKELING SESSIONS
- UNPARALLELED BREATHING COMFORT DUE TO THE INCREASED INTERNAL VOLUME OF THE BOTTOM HOUSING



COLOR VARIATIONS



REBEL FLEX

NEW

code: 411489

- SLIDING SNORKEL KEEPER
- CORRUGATED SILICONE HOSE AND MOUTHPIECE
- EXHAUST VALVE
- SUITABLE FOR DIVING OR EXTENDED SNORKELING SESSIONS
- UNPARALLELED BREATHING COMFORT DUE TO THE INCREASED INTERNAL VOLUME OF THE BOTTOM HOUSING



COLOR VARIATIONS



ERGO DRY

code: 411481

- 100% DRY TOP
- SLIDING SWIVEL SNORKEL KEEPER
- CORRUGATED SILICONE HOSE AND MOUTHPIECE
- EXHAUST VALVE
- SUITABLE FOR DIVING OR EXTENDED SNORKELING SESSIONS



ERGO SPLASH

code: 411480

- SEMIDRY TOP WITH ANTI-SPLASH
- SLIDING SWIVEL SNORKEL KEEPER
- CORRUGATED SILICONE HOSE AND MOUTHPIECE
- EXHAUST VALVE
- SUITABLE FOR DIVING OR EXTENDED SNORKELING SESSIONS



COLOR VARIATIONS



ERGO FLEX

code: 411482

- SLIDING SWIVEL SNORKEL KEEPER
- CORRUGATED SILICONE HOSE AND MOUTHPIECE
- EXHAUST VALVE
- SUITABLE FOR DIVING OR EXTENDED SNORKELING SESSIONS



COLOR VARIATIONS



COLOR VARIATIONS



SNORKEL @

code: 411479

- ERGONOMIC SHAPE
- ROLL UP, COMPACT DESIGN
- FITS IN A BCD POCKET OR CAN BE ATTACHED TO A BC
- ALL SILICONE DESIGN FOR FLEXIBILITY AND DURABILITY
- TUBE TOP DESIGN MADE TO PREVENT WATER ENTRY WHILE SNORKELING
- IDEAL FOR TRAVELLING



COLOR VARIATIONS



BK

WH

PRO FLEX

code: 411460

- BI-MATERIAL SOFT CONSTRUCTION
- CURVED, ERGONOMIC STRUCTURE
- NO AIRFLOW INTERRUPTIONS TO REDUCE NOISE AND VIBRATIONS
- SLIDING KEEPER
- SILICONE MOUTHPIECE FOR EXTENDED USE



PLUTO

NEW

code: 411486

- 100% DRY TOP SNORKEL DEDICATED TO JUNIORS
- SLIDING SNORKEL KEEPER
- SILICONE MOUTHPIECE
- EXHAUST VALVE
- WHISTLE ON BOTTOM AS SAFETY DEVICE



COLOR VARIATIONS

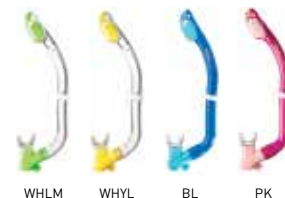

WHLM

WHYL

BL

PK

TECHNICAL SPECIFICATIONS



Snorkel	Rebel Dry	Rebel Splash	Rebel Flex	Ergo Dry	Ergo Splash	Ergo Flex	Snorkel @	Pro Flex	Pluto
Code	411487	411488	411489	411481	411480	411482	411479	411460	411486
Colors	<ul style="list-style-type: none"> ■ BKLM ■ BKBL ■ BKRD ■ BKYL ■ BKWH ■ WHRD ■ WHPK ■ WHBK 	<ul style="list-style-type: none"> ■ BKWH ■ BKPK ■ WHRD ■ WHBK 	<ul style="list-style-type: none"> ■ BKWH ■ BKBL ■ WHLM ■ WHYL 	<ul style="list-style-type: none"> ■ RYL ■ RBL ■ BK ■ CL ■ JPK ■ WH ■ BWH ■ BRD ■ BYL ■ BLM 	<ul style="list-style-type: none"> ■ RYL ■ RBL ■ BK ■ CL 	<ul style="list-style-type: none"> ■ RYL ■ RBL ■ BK ■ RD 	<ul style="list-style-type: none"> ■ BK □ WH 	<ul style="list-style-type: none"> ■ BK 	<ul style="list-style-type: none"> ■ WHLM ■ WHYL ■ BL ■ PK
DRY TOP	■			■					■
PURGE VALVE	■	■	■	■	■	■			■

ACCESSORIES

MASK STRAP

code: 415115 WHITE

code: 415116 BLACK

- MASK STRAP FOR LIQUIDSKIN MASKS
- WIDTH: 14 mm/0.55 in - LENGTH: 580 mm/22.8 in
- BI-SILICONE MATERIAL

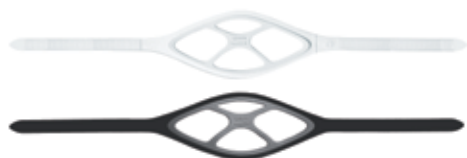

MASK STRAP

code: 415105 CLEAR

code: 415106 BLACK

- UNIVERSAL MASK STRAP
- WIDTH: 14 mm/0.55 in - LENGTH: 560 mm/22.0 in
- SILICONE MATERIAL



STRAP COVER

code: 412901

code: 412902 She Dives

- ONE SIZE FITS ALL
- SOFT NEOPRENE MASK STRAP COVER
- HELPS TO KEEP THE MASK STRAP IN PLACE
- HIGH COMFORT
- TANGLE-FREE DIVE



ANTIFOG

code: 415101

- GEL TO PREVENT MASK LENSES FROM FOGGING UP
- OPEN/CLOSE CAP WITH BRUSH
- MADE IN COMPLIANCE WITH LATEST REGULATIONS
- 60 ml





ACCESSORIES

EOS 20RZ

NEW

code: 415677

- 2300 LUMENS
- MAGNETIC ADJUSTABLE FOCUS
- 100 MINUTES OF BURN TIME (MAX POWER)
- IN-HOUSE RECHARGEABLE BATTERY
- USB RECHARGEABLE CABLE
- LED CHARGE INDICATOR
- WIDE LIGHT BEAM
- MAGNETIC MULTIFUNCTION SWITCH WITH SAFETY LOCK
- FOUR OPTIONS: ON, LOW, FLASH, OFF
- ONE-HAND USE
- TUBULAR HANDLE
- ADJUSTABLE WRIST STRAP



TECHNICAL FEATURES

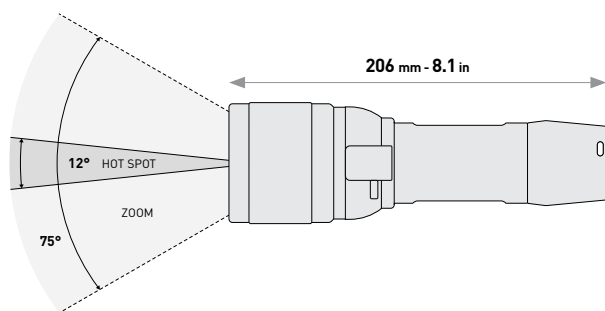

Bulb	3 Cree XP-L LED Chip		
Switch mode	High	Low	Flash/SOS
Led lumens (25°)	2300	690	/
Burn time (min)	100	180	310
Color temperature (k)	5700-7800		
Light beam (1m distance)	Hot Spot (12°)	Corona (75°)	
(Mm/in)	230 / 9.0	1550 / 61	
Rechargeable batteries (li-ion)	1x ICR26800		
Time to charge	7h (5V1A adapter) - 14h (PC 500mA)		
Total length (mm/in)	206 / 8.1		
Head diameter (mm/in)	62 / 2.4		
Body diameter (mm/in)	37 / 1.5		
Weight with batteries (gr/oz)	594 / 20.9		
Max operating depth (m/feet)	120 / 393		

EOS 15RZ

NEW

code: 415678

- 1504 LUMENS
- MAGNETIC ADJUSTABLE FOCUS
- 125 MINUTES OF BURN TIME (MAX POWER)
- IN-HOUSE RECHARGEABLE BATTERY
- USB RECHARGEABLE CABLE
- LED CHARGE INDICATOR
- WIDE LIGHT BEAM
- MAGNETIC MULTIFUNCTION SWITCH WITH SAFETY LOCK
- FOUR OPTIONS: ON, LOW, FLASH, OFF
- ONE-HAND USE
- TUBULAR HANDLE
- ADJUSTABLE WRIST STRAP



TECHNICAL FEATURES

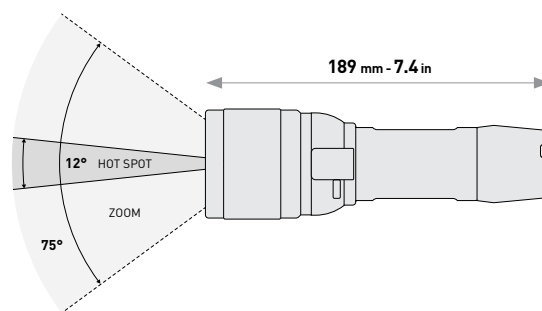

Bulb	3 Cree XP-G2 LED Chip		
Switch mode	High	Low	Flash/SOS
Led lumens (25°)	1504	500	/
Burn time (min)	125	185	180
Color temperature (k)	5800 ÷ 7300		
Light beam (1m distance)	Hot Spot (12°)	Corona (75°)	
(Mm/in)	230 / 9.0	1550 / 61	
Rechargeable batteries (li-ion)	1x ICR26650		
Time to charge	6 h (5V1A adapter) - 12 h (PC 500mA)		
Total length (mm/in)	189 / 7.4		
Head diameter (mm/in)	62 / 2.4		
Body diameter (mm/in)	37 / 1.5		
Weight with batteries (gr/oz)	553 / 19.5		
Max operating depth (m/feet)	120 / 393		

EOS 10RZ

NEW

code: 415679

- 1010 LUMENS
- MAGNETIC ADJUSTABLE FOCUS
- 135 MINUTES OF BURN TIME (MAX POWER)
- IN-HOUSE RECHARGEABLE BATTERY
- USB RECHARGEABLE CABLE
- LED CHARGE INDICATOR
- WIDE LIGHT BEAM
- MAGNETIC MULTIFUNCTION SWITCH WITH SAFETY LOCK
- FOUR OPTIONS: ON, LOW, FLASH, OFF
- ONE-HAND USE
- TUBULAR HANDLE
- ADJUSTABLE WRIST STRAP



TECHNICAL FEATURES

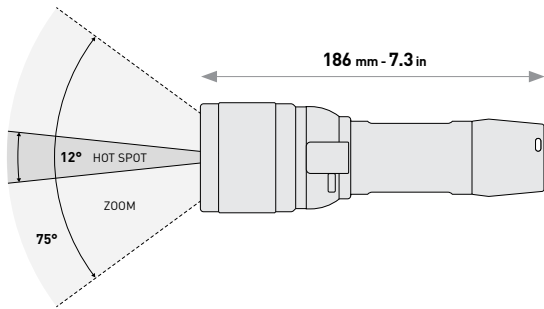

Bulb	1 Cree XM-L2 LED Chip		
Switch mode	High	Low	Flash/SOS
Led lumens (25°)	1010	365	/
Burn time (min)	135	255	240
Color temperature (k)	5800 ÷ 7300		
Light beam (1m distance)	Hot Spot (12°)	Corona (75°)	
(Mm/in)	220 / 8.6	1550 / 61	
Rechargeable batteries (li-ion)	1x ICR26650		
Time to charge	6 h [5V1A adapter] - 12 h [PC 500mA]		
Total length (mm/in)	186 / 7.3		
Head diameter (mm/in)	57 / 2.2		
Body diameter (mm/in)	37 / 1.5		
Weight with batteries (gr/oz)	537 / 18.8		
Max operating depth (m/feet)	120 / 393		

EOS 5RZ

NEW

code: 415680

- 503 LUMENS
- ADJUSTABLE FOCUS
- 105 MINUTES OF BURN TIME (MAX POWER)
- IN-HOUSE RECHARGEABLE BATTERY
- USB RECHARGEABLE CABLE
- LED CHARGE INDICATOR
- WIDE LIGHT BEAM
- MAGNETIC MULTIFUNCTION SWITCH WITH SAFETY LOCK
- FOUR OPTIONS: ON, LOW, FLASH, OFF
- ONE-HAND USE
- TUBULAR HANDLE
- ADJUSTABLE WRIST STRAP



TECHNICAL FEATURES

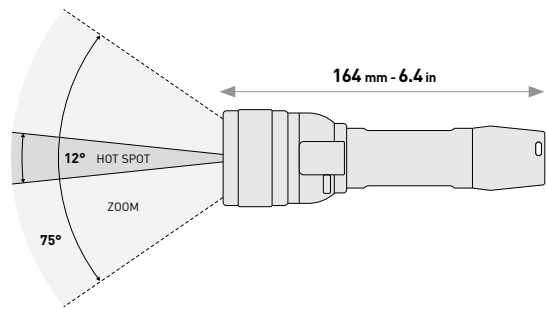

Bulb	1 Cree XP-G2 LED Chip		
Switch mode	High	Low	Flash/SOS
Led lumens (25°)	503	165	/
Burn time (min)	105	270	220
Color temperature (k)	5800 ÷ 7300		
Light beam (1m distance)	Hot Spot (12°)	Corona (75°)	
(Mm/in)	220 / 8.6	1550 / 61	
Rechargeable batteries (li-ion)	1x ICR18650		
Time to charge	4 h 30' [5V1A adapter] - 6 h [PC 500mA]		
Total length (mm/in)	164 / 6.4		
Head diameter (mm/in)	43 / 1.7		
Body diameter (mm/in)	29 / 1.1		
Weight with batteries (gr/oz)	280 / 9.8		
Max operating depth (m/feet)	120 / 393		

EOS 3RZ

NEW

code: 415681

- 320 LUMENS
- ADJUSTABLE FOCUS
- 55 MINUTES OF BURN TIME (MAX POWER)
- IN-HOUSE RECHARGEABLE BATTERY
- USB RECHARGEABLE CABLE
- LED CHARGE INDICATOR
- WIDE LIGHT BEAM
- MAGNETIC MULTIFUNCTION SWITCH WITH SAFETY LOCK
- FOUR OPTIONS: ON, LOW, FLASH, OFF
- ONE-HAND USE
- TUBULAR HANDLE
- ADJUSTABLE WRIST STRAP



EOS STROBE

NEW

code: 415682

- 450 LUMENS
- 360° HIGH VISIBILITY
- 15/20 HOURS OF BURN TIME
- IN-HOUSE RECHARGEABLE BATTERY
- USB RECHARGEABLE CABLE
- LED CHARGE INDICATOR
- MAGNETIC, ROTATIONAL SWITCH
- TWO OPERATING MODES: ON, STROBE
- ANODIZED ALUMINUM HOUSING
- ADJUSTABLE STRAP



TECHNICAL FEATURES

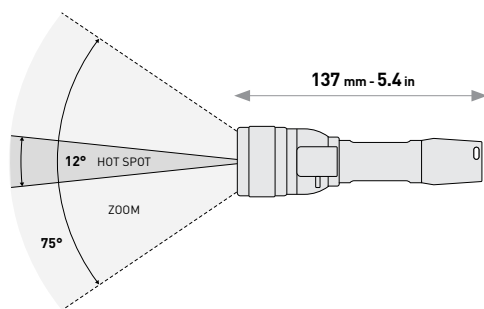

Bulb	1 Cree XPE LED Chip		
Switch mode	High	Low	Flash/SOS
Led lumens (25°)	320	105	/
Burn time (min)	55	120	130
Color temperature (k)	6700 ÷ 7800		
Light beam (1m distance)	Hot Spot (12°)	Corona (75°)	
(Mm/in)	220 / 8.6	1550 / 61	
Rechargeable batteries (li-ion)	1x ICR14500		
Time to charge	3 h (5V1A adapter) - 3 h (PC 500mA)		
Total length (mm/in)	137 / 5.4		
Head diameter (mm/in)	35 / 1.3		
Body diameter (mm/in)	23 / 0.9		
Weight with batteries (gr/oz)	152 / 5.3		
Max operating depth (m/feet)	120 / 393		

TECHNICAL FEATURES

Bulb	1 Cree XPE LED Chip	
Switch mode	High	Flash/SOS
Led lumens (25°)	450	/
Burn time (min)	300	1500
Color temperature (k)	5800 ÷ 7300	
Light beam (1m distance)	Diffused light	
Flash Rate (p/min)	120	
Rechargeable batteries (li-ion)	1x ICR26650	
Time to charge	6 h (5V1A adapter) - 12 h (PC 500mA)	
Total length (mm/in)	170 / 6.6	
Head diameter (mm/in)	39 / 1.6	
Body diameter (mm/in)	34 / 1.4	
Weight with batteries (gr/oz)	245 / 8.6	
Max operating depth (m/feet)	100 / 328	

EOS 5

code: 415669

- HI-POWER 7W MONO LED
- ANODIZED ALUMINUM HOUSING
- ROTATIONAL HEAD SWITCH
- 3 TYPE C ALKALINE BATTERIES (NOT INCLUDED)
- USER REPLACEABLE BATTERIES
- TUBULAR HANDLE
- ADJUSTABLE WRIST STRAP



TECHNICAL FEATURES

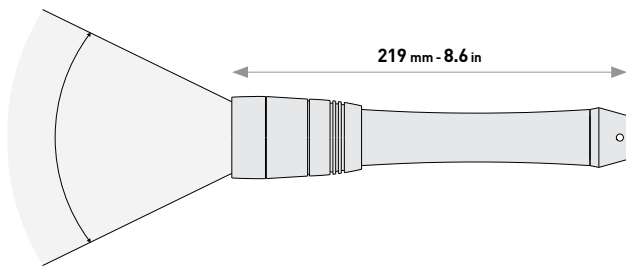

Bulb	1 Mono LED XLM CREE
Color Temperature (K)	6.000
Light Intensity Control	NO
** Hot Spot Diameter (mm/in)	140/5.51
Switch	Rotational
Lumens (25°)	620
** Hot Spot Brightness (lux)	13.000
Burn Time	14-16h
Switch Operation	Mechanical
Batteries	3xC (Alkaline)
Rechargeable Batteries	OPTION (2700 mAh)
Total Length (mm/in)	219 / 8.6
Head Diameter (mm/in)	44 / 1.73
Body Diameter (mm/in)	31 / 1.22
Weight (gr/oz) (*wo batteries)	211 / 7.44 (*)
Max Operating Depth (m/feet)	120 / 393

** Characteristics of the beam of light are measured at a distance of 800 mm / 31.5 in.

EOS 2C

code: 415668

- 3W MONO LED
- ANODIZED ALUMINUM HOUSING
- ROTATIONAL HEAD SWITCH
- 3 TYPE AAA ALKALINE BATTERIES (NOT INCLUDED)
- USER REPLACEABLE BATTERIES
- TUBULAR HANDLE
- ADJUSTABLE WRIST STRAP



TECHNICAL FEATURES

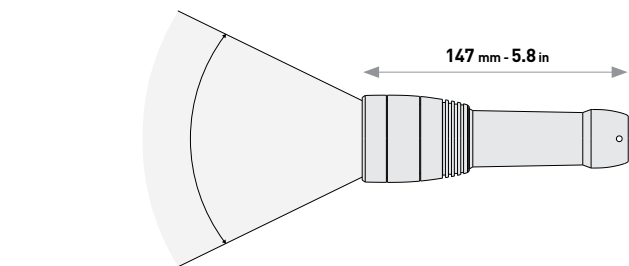

Bulb	1 Mono LED XPG CREE
Color Temperature (K)	6.000
Light Intensity Control	NO
** Hot Spot Diameter (mm/in)	140/5.51
Switch	Rotational
Lumens (25°)	240
** Hot Spot Brightness (lux)	17.000
Burn Time	5-6h
Switch Operation	Mechanical
Batteries	3xAAA (Alkaline)
Rechargeable Batteries	OPTION (2700 mAh)
Total Length (mm/in)	147 / 5.78
Head Diameter (mm/in)	44 / 1.73
Body Diameter (mm/in)	28 / 1.10
Weight (gr/oz) (*wo batteries)	197 / 6.94 (*)
Max Operating Depth (m/feet)	120 / 393

** Characteristics of the beam of light are measured at a distance of 800 mm / 31.5 in.

TORCH ADAPTER

code: 415179

- TURN THE TORCH INTO A VIDEO LIGHT
- DESIGNED FOR FLEXIBLE ARM
- A QUICK, EASY AND RELIABLE SOLUTION
- 3 SIZES (S/21 mm - M/27mm - L/34 mm)
- STAINLESS STEEL WITH RUBBER PROTECTION



SOFT GOODMAN HANDLE **NEW**

code: 415180

- ADJUSTABLE HAND STRAP TO BE USED EVEN WITH THICK GLOVES
- SAFETY WRIST STRAP FOR A PERFECT FIT
- DOUBLE ADJUSTABLE VELCRO STRAPS
- CAN BE USED WITH ALL EOS LIGHTS
- RELIABLE AND STURDY MATERIAL
- ADDITIONAL D-RING TO SECURE THE TORCH



MARKER BEAM

code: 415711

- FLASHING LIGHT STICK
- SAFETY LEASH WITH STOP
- LR 44 BATTERIES



STROBE BEAM

code: 415710

- TWO-IN-ONE STROBE AND LED TORCH UNIT
- MAGNETIC SWITCH
- LED BACK-UP TORCH
- 3 TYPE AA ALKALINE BATTERIES (NOT INCLUDED)
- ADJUSTABLE WRIST STRAP



CRUISE SYSTEM

code: 415500

- TELESCOPING HANDLE
- WIDE WHEEL PLACEMENT
- EXTERNAL HOOK WITH DEDICATED POCKET
- ADJUSTABLE EXTERNAL COMPRESSION STRAPS
- ULTRA-LIGHT BUCKLES
- FRONT AND SIDE HANDLES
- 3 UNIVERSAL HANGERS WITH DOUBLE ATTACHMENT, INCLUDED
- RINSE AND DRY EQUIPMENT INSIDE THE BAG
- OPEN/CLOSE VENTILATION SYSTEM
- FOUR INTERNAL MESH POCKETS
- DETACHEABLE MESH BAG WITH DRAINING SYSTEM



TECHNICAL FEATURES

Dimensions (LxWxH)	Unit Net Weight	Volume
51x31x79 cm / 20"x12"x31"	5,9 Kg / 13.2 lb	122 L / 7436 cu.in.

CRUISE BACKPACK

code: 415510

- TELESCOPING HANDLE
- LARGE STURDY WHEELS
- EXTERNAL FIN POCKETS WITH DRAINAGE SYSTEM
- ADJUSTABLE EXTERNAL COMPRESSION STRAPS
- ULTRA-LIGHT BUCKLES
- AIR MESH HANDLE
- PADDED SHOULDER STRAPS
- INTEGRATED FRONT POCKETS
- A.T.O. - AIR TRAVEL OPTIMIZED



TECHNICAL FEATURES

Dimensions (LxWxH)	Unit Net Weight	Volume
40x31x80 cm / 16"x12"x31.5"	4,4 Kg / 9.7 lb	100 L / 6071 cu.in.

CRUISE BACKPACK PRO

code: 415541

- TELESCOPING HANDLE
- LARGE STURDY WHEELS
- EXTERNAL FIN POCKETS WITH DRAINAGE SYSTEM
- ADJUSTABLE EXTERNAL COMPRESSION STRAPS
- ULTRA-LIGHT BUCKLES
- AIR MESH HANDLE
- PADDED SHOULDER STRAPS
- INTEGRATED FRONT POCKETS
- TOILETRY BAG WITH INTERNAL MIRROR
- A.T.O. - AIR TRAVEL OPTIMIZED



TECHNICAL FEATURES

Dimensions (LxWxH)	Unit Net Weight	Volume
47x32x81 cm / 18.5"x12.5"x32"	5 Kg / 11 lb	128 L / 7811 cu.in.

CRUISE ROLLER

code: 415542

- EASY TO FOLD AND STOW
- LARGE STURDY WHEELS
- EXTERNAL FIN POCKETS WITH DRAINAGE SYSTEM
- ADJUSTABLE EXTERNAL COMPRESSION STRAPS
- ULTRA-LIGHT BUCKLES
- AIR MESH HANDLE
- PADDED SHOULDER STRAPS
- INTEGRATED FRONT POCKETS
- LIGHTWEIGHT
- A.T.O. - AIR TRAVEL OPTIMIZED



TECHNICAL FEATURES

Dimensions (LxWxH)	Unit Net Weight	Volume
47x32x81 cm / 18.5"x12.5"x32"	3 Kg / 6.6 lb	128 L / 7811 cu.in.

CRUISE BUDDY

code: 415456

- TELESCOPING HANDLE
- WIDE WHEEL BASE FOR STABILITY
- ADJUSTABLE EXTERNAL COMPRESSION STRAPS
- TWO AIR MESH HANDLES
- INTEGRATED FRONT POCKETS WITH ZIPPERS
- ADJUSTABLE INTERNAL TIE-DOWN STRAPS
- BUSINESS CARD WINDOWS
- LIGHTWEIGHT
- A.T.O. - AIR TRAVEL OPTIMIZED



TECHNICAL FEATURES

Dimensions (LxWxH)	Unit Net Weight	Volume
43x27x75 cm / 17" x 10.5" x 29.5"	3,5 Kg / 7.7 lb	87 L / 5309 cu.in.

CRUISE BACKPACK DRY

code: 415540

- ULTRA LIGHTWEIGHT
- COMPLETELY WATERTIGHT
- LARGE INTERNAL VOLUME
- ADJUSTABLE, PADDED AND REMOVABLE SHOULDER STRAPS
- ULTRALIGHT BUCKLES



TECHNICAL FEATURES

Dimensions (LxWxH)	Unit Net Weight	Volume
42x33x79 cm / 16.5"x13x31	1,1 Kg / 2.4 lb	108 L / 6590 cu.in.

CRUISE CAPTAIN

code: 415558

- TELESCOPING HANDLE
- WIDE WHEEL PLACEMENT
- EXPANDABLE POCKET WITH ZIPPER
- INTEGRATED FRONT POCKET
- WIDE INTERNAL MESH POCKET
- COMPRESSION STRAPS WITH ULTRALIGHT BUCKLES
- TOP AND LATERAL SIDE AIR MESH HANDLES
- A.T.O. - AIR TRAVEL OPTIMIZED



TECHNICAL FEATURES

Dimensions (LxWxH)	Unit Net Weight	Volume
36x22x55cm / 14"x8.5"x22"	2,8 Kg / 6.2 lb	42 L / 2563 cu.in.

CRUISE QUICK PACK

code: 415598

- CAN BE FOLDED INTO A SMALL BAG WITH HANDLE
- WATER REPELLENT COATING
- INTERNAL POCKET
- MESH COVER WITH DRAWSTRING CLOSURE
- EXTREMELY LIGHTWEIGHT



TECHNICAL FEATURES

Dimensions (LxWxH)	Unit Net Weight	Volume
80x39x37 cm / 31.5"x15.5"x14.5"	0,9 Kg / 2 lb	116 L / 7079 cu.in.

CRUISE X-STRAP

code: 415543

- EASY TO FOLD
- TWO LARGE INTEGRATED POCKETS
- ULTRA-LIGHT BUCKLES
- NEOPRENE HANDLES
- ADJUSTABLE, PADDED AND REMOVABLE SHOULDER STRAPS
- AUTO-BLOCKING ZIP
- EXTREMELY LIGHTWEIGHT



TECHNICAL FEATURES

Dimensions (LxWxH)	Unit Net Weight	Volume
76x31x33 cm / 30"x12"x13"	1,2 Kg / 2.6 lb	76 L / 4637 cu.in.

CRUISE CLASSIC

code: 415559

- HANDLE AND SHOULDER STRAPS
- EXTERNAL FIN POCKET WITH BUCKLE
- ZIP POCKET FOR PERSONAL BELONGINGS
- STURDY AND LIGHTWEIGHT
- REINFORCED BOTTOM



TECHNICAL FEATURES

Dimensions (LxWxH)	Unit Net Weight	Volume
76x29x36 cm / 30"x11.5"x14"	2 Kg / 4.4 lb	79 L / 4821 cu.in.

CRUISE POOL

code: 415511

- EXTREMELY LIGHTWEIGHT
- EXTERNAL ZIP POCKET
- REINFORCED BOTTOM
- WIDE, LONG STRAP



TECHNICAL FEATURES

Dimensions (LxWxH)	Unit Net Weight	Volume
69x26x29 cm / 27"x10"x11"	0,7 Kg / 1.5 lb	50 L / 3057 cu.in.

CRUISE BACKPACK MESH DELUXE

code: 415596

- STURDY PVC MESH NET
- ADJUSTABLE SHOULDER AND STERNUM STRAP
- LATERAL ZIP AND STURDY HANDLE
- BOTTOM PROTECTION
- INTERNAL POCKET
- WIDE EXTERNAL POCKET
- BOTTOM EXTENSION WITH DRAINAGE HOLE
- DRAWSTRING CLOSURE



TECHNICAL FEATURES

Dimensions (LxWxH)	Unit Net Weight	Volume
41x41x75 cm / 16"x16"x29.5"	1,2 Kg / 2.6 lb	123,5 L / 7536 cu.in.

CRUISE BACKPACK MESH ELITE

code: 415597

- CAN BE FOLDED INTO A SMALL BAG WITH HANDLE
- LIGHTWEIGHT
- INTEGRATED SOFT HANDLE
- BOTTOM PROTECTION
- INTERNAL POCKET
- WIDE EXTERNAL POCKET
- BOTTOM EXTENSION WITH DRAINAGE HOLE
- ADJUSTABLE SHOULDER STRAPS



TECHNICAL FEATURES

Dimensions (LxWxH)	Unit Net Weight	Volume
39x39x74 cm / 15.5"x15.5"x29"	0,5 Kg / 1.1 lb	114 L / 6956 cu.in.

CRUISE DRY BAGS

D55

code: 415451

- DRY 55L DUFFLE BAG
- DOUBLE CLOSURE SYSTEM
- LARGE INTERNAL VOLUME
- HAND STRAP & ADJUSTABLE SHOULDER STRAP
- STURDY 500D TARPULIN
- IDEAL FOR WATERSPORTS AND OUTDOOR ACTIVITIES
- SVHC FREE MATERIAL



TECHNICAL FEATURES

Dimensions (LxWxH)	Unit Net Weight	Volume
60x30x55 cm / 23.5" x 12" x 21.5"	0,9 Kg / 2 lb	55 L / 3356 cu.in.

MBP15

code: 415450

- MODULAR 15L BACKPACK
- ROLL NECK & BUCKLE CLOSURE SYSTEM
- ADJUSTABLE, PRE-SHAPED SHOULDER STRAPS
- PADDED BACKPACK
- ADJUSTABLE CHEST AND WAIST STRAPS
- REMOVABLE LAPTOP AND GADGET SLEEVE
- REMOVABLE MESH POCKET
- STURDY 500D TARPULIN
- IDEAL FOR WATERSPORTS AND OUTDOOR ACTIVITIES
- SVHC FREE MATERIAL



TECHNICAL FEATURES

Dimensions (LxWxH)	Unit Net Weight	Volume
40x12x65cm / 16" x 5" x 25.5"	1,2 Kg / 2.6 lb	15 L / 915 cu.in.

CRUISE DRY T

T35

code: 415452

T25

code: 415453

T10

code: 415454

T5

code: 415455

- DRY BAG TUBULAR AVAILABLE IN FOUR SIZES AND COLORS
- COLOR & SIZE SYSTEM
- ADJUSTABLE SHOULDER STRAP
- QUICK CLOSURE SYSTEM
- STURDY 500D TARPULIN
- IDEAL FOR WATERSPORTS AND OUTDOOR ACTIVITIES
- SVHC FREE MATERIAL



CRUISE DRY ULTRA LIGHT

NEW

T-LIGHT 25 L

code: 415461

T-LIGHT 10 L

code: 415462

T-LIGHT 5 L

code: 415463

- REINFORCED, LIGHTWEIGHT POLYESTER
- QUICK CLOSURE SYSTEM
- HEAT-SEALED STITCHING
- FULLY WATERPROOF
- EXCELLENT FOR WATER SPORTS
- IDEAL FOR OUTDOOR ACTIVITIES
- AVAILABLE IN THREE DIFFERENT SIZES
- SVHC FREE MATERIALS

BP-LIGHT 75 L

code: 415460

- ROLLING CLOSURE SYSTEM
- ADJUSTABLE, PADDED SHOULDER STRAPS
- ADJUSTABLE WAIST STRAPS
- STURDY, LIGHTWEIGHT 210D POLYESTER
- FRONT POCKET WITH WATERPROOF ZIPPER
- IDEAL FOR WATER SPORTS AND OUTDOOR ACTIVITIES
- SVHC FREE MATERIALS



CRUISE JOURNEY

code: 415545

- CAMERA COMPARTMENT
- REAR ZIPPED LAPTOP POCKET
- ADJUSTABLE PADDED SHOULDER STRAPS
- INTERNAL PADDING
- AIR MESH HANDLE
- MULTI-USE POCKETS
- EXTERNAL ELASTIC
- WIDE BAND FOR TELESCOPIC HANDLE
- ULTRALIGHT MATERIAL
- A.T.O. - AIR TRAVEL OPTIMIZED



TECHNICAL FEATURES

Dimensions (LxWxH)	Unit Net Weight	Volume
42x23x48 cm / 16.5"x9"x19"	1,3 Kg / 2.8 lb	27 L / 1648 cu.in.

CRUISE REG

code: 415546

- ADJUSTABLE SHOULDER STRAP
- ADDITIONAL COMPUTER BAG, REMOVABLE
- INTERNAL ZIPPED MESH POCKET
- VELCRO STRAPS TO ATTACH REGULATORS
- BUSINESS CARD POCKET



TECHNICAL FEATURES

Dimensions (LxWxH)	Unit Net Weight	Volume
26x10x36 cm / 10"x4"x14"	0,25 Kg / 0.55 lb	9.4 L / 573 cu.in.

CRUISE MESH

code: 415576

- FULL MESH
- TO STORE SCUBA DIVING OR FREE DIVING EQUIPMENT
- CAN BE FOLDED INTO A ROUND BAG WITH HANDLE



MESH BAG

code: 415515

- PRACTICAL AND COMPACT MESH SACK
- EASY TO CARRY AND FOR RINSING EQUIPMENT
- IDEAL FOR SNORKELING



CRUISE DIVER

code: 415590

- ADJUSTABLE SHOULDER STRAP
- DEDICATED POCKET FOR COMPUTER AND INTERFACE
- MOBILE PHONE POCKET
- MANY PLACES FOR ELECTRONIC DEVICES
- KEY HOLDER
- CARD HOLDER



CRUISE PEARL

code: 415584

- VELCRO CLOSURE SYSTEM
- TO STORE AND PROTECT YOUR MASK
- CAN BE ATTACHED TO BELT
- DEDICATED ANTIFOG POCKET



TECHNICAL SPECIFICATIONS



Bag	Cruise System	Cruise Backpack Pro	Cruise Backpack	Cruise Roller	Cruise Buddy	Cruise Backpack Dry	Cruise Captain	Cruise Quick Pack
Code	415500	415541	415510	415542	415456	415540	415558	415598
Dimensions (LxWxH)	51x31x79 cm 20"x12"x31"	47x32x81 cm 18.5"x12.5"x32"	40x31x80 cm 16"x12"x31.5"	47x32x81 cm 18.5"x12.5"x32"	47x32x81 cm 17"x10.5"x29.5"	42x33x79 cm 16.5"x13"x31"	36x22x55 cm 14"x8.5"x22"	80x39x37 cm 31.5"x15.5"x14.5"
Unit Net Weight	5,9 Kg / 13.2 lb	5 Kg / 11 lb	4,4 Kg / 9.7 lb	3 Kg / 6.6 lb	3,5 Kg / 7.7 lb	1,1 Kg / 2.4 lb	2,8 Kg / 6.2 lb	0,9 Kg / 2 lb
Volume	122 L / 7436 cu.in.	128 L / 7811 cu.in.	100 L / 6071 cu.in.	128 L / 7811 cu.in.	87 L / 5309 cu.in.	108 L / 6590 cu.in.	42 L / 2563 cu.in.	116 L / 7079 cu.in.
A.T.O. AIR TRAVEL OPTIMIZED	■	■	■	■	■	■	■	
HEAVY DUTY WHEELS	■	■	■	■	■		■	
BACKPACK SYSTEM		■	■	■		■		
FOLDABLE SYSTEM				■				■



Bag	Cruise X-strap	Cruise Classic	Cruise Pool	Cruise Mesh Deluxe	Cruise Mesh Elite	Cruise Journey	Cruise Reg	Cruise Mesh
Code	415543	415559	415511	415596	415597	415545	415546	415576
Dimensions (LxWxH)	76x31x33 cm 30"x12"x13"	76x29x36 cm 30"x11.5"x14"	69x26x29 cm 27"x10"x11"	41x41x75 cm 16"x16"x29.5"	39x39x74 cm 15.5"x15.5"x29"	42x23x48 cm 16.5"x9"x19"	26x10x36 cm 10"x4"x14"	95.3x38.1x38.1 cm 37.5"x15"x15"
Unit Net Weight	1,2 Kg / 2.6 lb	2 Kg / 4.4 lb	0,7 Kg / 1.5 lb	1,2 Kg / 2.6 lb	0,5 Kg / 1.1 lb	1,3 Kg / 2.9 lb	0,25 Kg / 0.55 lb	0,67 Kg / 1.48 lb
Volume	76 L / 4637 cu.in.	79 L / 4821 cu.in.	50 L / 3057 cu.in.	123,5 L / 7536 cu.in.	114 L / 6956 cu.in.	27 L / 1648 cu.in.	9.4 L / 573 cu.in.	108.5 L / 6623 cu.in.
A.T.O. AIR TRAVEL OPTIMIZED	■	■	■					
HEAVY DUTY WHEELS								
BACKPACK SYSTEM	■			■	■	■		
FOLDABLE SYSTEM					■			■



Dry Bag	T5	T10	T25	T35	T-LIGHT 5 L	T-LIGHT 10 L	T-LIGHT 25 L	BP-LIGHT 75 L
Code	415455	415454	415453	415452	415463	415462	415461	415460
Polyester Density	-	-	-	-	75	75	210	210
Dimensions (DxH)	16,5x29 cm 6.5x11.4 inch	19,5x33,5 cm 7.7x13.2 inch	25,5x56,5 cm 10.0x22.2 inch	25,5x69 cm 10.0x27.2 inch	15x48 cm 5.9x18.9 inch	20x35 cm 7.8x13.7 inch	24x57,5 cm 9.4x22.6 inch	41x22,5x83 cm 16.1x8.8x32.6 inch
Weight	0,14 Kg / 0.31 lb	0,17 Kg / 0.38 lb	0,35 Kg / 0.77 lb	0,40 Kg / 0.89 lb	0,05 Kg / 0.11 lb	0,06 Kg / 0.13 lb	0,11 Kg / 0.24 lb	0,40 Kg / 0.89 lb
Volume	5 L / 305 cu.in.	10 L / 610 cu.in.	25 L / 1525 cu.in.	35 L / 2136 cu.in.	5 L / 305 cu.in.	10 L / 610 cu.in.	25 L / 1525 cu.in.	75 L / 4577 cu.in.

JACKET

code: 449127



TECHNICAL FEATURES

	Unisex
Size	XS · S · M · L · XL · XXL
Characteristics	Waterproof / Refolding hood

HOODED SWEATER

code: 449129



TECHNICAL FEATURES

	Unisex
Size	XS · S · M · L · XL · XXL
Characteristics	100% cotton

POLO

code: 449130



TECHNICAL FEATURES

	Unisex
Size	XS · S · M · L · XL · XXL
Characteristics	100% cotton

T-SHIRT

code: 449128



TECHNICAL FEATURES

	Unisex
Size	XS · S · M · L · XL · XXL
Characteristics	100% cotton

FORCE PLUS

code: 415626

- SOFT OVERMOLDED ERGONOMIC HANDLE
- FITS ON MARES BCDS, BAGS AND HOSES
- EASY RELEASE SYSTEM, EVEN WITH GLOVES



TECHNICAL FEATURES

Blade	Stainless Steel - PVD Coated
Blade length	100 mm / 3.9 in

FORCE NANO PLUS

code: 415627

- SOFT OVERMOLDED ERGONOMIC HANDLE
- FITS ON MARES BCDS, BAGS AND HOSES
- EASY RELEASE SYSTEM, EVEN WITH GLOVES



TECHNICAL FEATURES

Blade	Stainless Steel - PVD Coated
Blade length	65 mm / 2.6 in

FORCE BAT TITANIUM

code: 415624*

- BETA TITANIUM BLADE WITH SPECIAL SERRATED EDGE
- 40% HARDER THAN TITANIUM
- EXTREMELY LIGHTWEIGHT
- CAN EASILY BE OPENED WITH ONE HAND
- CARABINER WITH NYLON STRAP INCLUDED



TECHNICAL FEATURES

Blade	Beta Titanium
Blade length	90 mm / 3.5 in

*Until stock lasts

SAFETY STOP MARKER

code: 415708*

- 3-5 m SAFETY/DECO STOP BUOY
- HIGH VISIBILITY ORANGE COLOR
- LARGE INTERNAL VOLUME
- HD CONSTRUCTION AND STRONG BRASS HOOK



*Until stock lasts

STANDARD MARKER

code: 415709

- HIGHLY VISIBLE EGG SHAPE
- ONE PIECE CONSTRUCTION WITH INTEGRATED FLAG
- TWO-CHAMBER CONSTRUCTION FOR SAFETY AND AN UPRIGHT POSITION
- 20 m ROPE
- VARIOUS HOOKS



TORPEDO

code: 415721

- LOW-DRAG TORPEDO SHAPE FOR EASY TOWING
- HIGH VISIBILITY ORANGE COLOR
- TWO-CHAMBER CONSTRUCTION FOR SAFETY AND AN UPRIGHT POSITION
- 20 m ROPE
- SIX UNIVERSAL ADJUSTMENT CONNECTORS



DIVER MARKER BUOY - ALL IN ONE **NEW**

code: 415753

- 180 cm HEIGHT
- 5 cm/2" SOLAS REFLECTIVE TAPE
- EXTREMELY LIGHTWEIGHT
- "DIVER BELOW" REFLECTIVE WRITING
- INTEGRATED MESH POCKET FOR SPOOL
- 20 m/66 ft SPOOL INCLUDED
- STAINLESS STEEL D-RING
- DOUBLE ENDER STAINLESS STEEL CARABINER
- ORAL INFLATE CONNECTOR FOR LP BCD HOSE
- OVER PRESSURE RELEASE VALVE
- VELCRO CLOSURE SYSTEM



DIVER'S ALERT MARKER

code: 415743

- 180 cm TALL AND 15 cm WIDE FOR HIGH VISIBILITY
- SOLAR REFLECTIVE TAPE
- AUTOMATIC SEAL SYSTEM
- ORAL INFLATION CONNECTOR FOR LP BCD HOSE
- PRESSURE RELEASE VALVE
- DEDICATED POCKET FOR LIGHT
- STAINLESS STEEL DRING



COMPACT

code: 415742

- ORANGE DIVER MARKER BUOY
- 10 m LINE
- 300g-2/3lbs SHAPED LEAD WEIGHT
- NYLON SACK WITH CARABINER



STANDARD INFLATABLE

code: 415707

- HIGH VISIBILITY ORANGE COLOR
- FOLDING BAG WITH HOOK
- 20 m ROPE AND VARIOUS HOOKS
- INTEGRATED WEIGHTS FOR PROPER SURFACE FLotation
- FITS IN BCD POCKET



COMPACT REEL

code: 415349

- FOLDABLE HANDLES
- DOUBLE ENDED CARABINER
- 30 m/100 ft LINE



UNIVERSAL HANGER

code: 415177

- HOLDS UP TO 15 DIFFERENT ITEMS
- UNIQUE MARES DESIGN
- STURDY AND ROBUST
- EQUIPMENT PERFECTLY ORGANIZED



DRYSUIT HANGER

code: 415713

- PERFECT FOR DRY SUITS WITH BOOTS
- BETTER VENTILATION BECAUSE THE DRY SUIT IS UPSIDE DOWN
- STURDY AND SIMPLE TO USE



WEIGHT BELT

code: 415122

- QUICK RELEASE PLASTIC BUCKLE



STAINLESS STEEL BELT

code: 415123

- QUICK RELEASE STAINLESS STEEL BUCKLE



LIQUID PATCH

code: 415181 BK

code: 415181 GR

- IDEAL FOR REPAIRING HOLES AND SMALL CUTS
- CAN BE USED ON NEOPRENE, BC VESTS, DRY SUITS AND MORE
- AVAILABLE IN BLACK AND GREY
- EASY TO USE, JUST THREE STEPS
- FLEXIBLE AND ELASTIC
- 20 gr



NEW

SILICONE GREASE

code: 415102

- IDEAL FOR MAINTENANCE AND TO LUBRICATE O-RINGS
- MADE IN COMPLIANCE WITH LATEST REGULATIONS
- 20 ml



SCUBA CLEAN

code: 415905 Desk Exhibitor (12pcs)

- MARES SANITIZER FOR ALL SCUBA GEAR
- TRIPLE ACTION: FUNGICIDE, BACTERICIDE AND VIRUCIDE
- OFFERS TOTAL DISINFECTION, CLEANLINESS AND SANITIZATION
- COMPATIBLE WITH PLASTIC, NYLON, NEOPRENE AND METAL
- 125 ml



SNORKELING VEST

code: 417750

- ONE SIZE FITS ALL
- SECURE AND COMFORTABLE SURFACE FLOTATION
- ADJUSTABLE ABDOMINAL STRAP
- QUICK-RELEASE BUCKLE
- EASILY ACCESSIBLE ORAL INFLATOR



SHELLS

- SHOCKPROOF CASE
- STURDY ZIPPER
- MARES MICRO-INJECTED LABEL
- SILVER PIPING

SHELL REGULATOR

NEW

code: 415866

- PERFECT SIZE FOR STORING REGULATORS
- DEDICATED HANDLE FOR EASY CARRYING



SHELL OVAL

code: 415864

- PERFECT FOR TORCHES, MASKS AND MORE



SHELL ROUND

code: 415865

- IDEAL FOR DIVE COMPUTERS



NOZZLE

code: 415724 Air Nozzle

code: 415725 Brass Air Nozzle

- EASY TO USE
- QUICK CONNECTION AND DISCONNECTION FROM LP INFLATOR HOSE
- USE AIR TO CLEAN AND DRY
- NOT ONLY FOR SCUBA EQUIPMENT

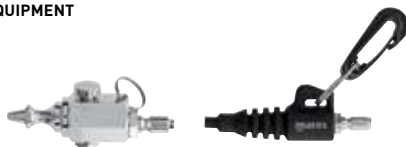

DIVING BOX

code: 415516

- TO STORE, PROTECT AND CARRY DIVING EQUIPMENT
- SIZES: 82X42X38 cm
- REMOVABLE HANDLE
- RELIABLE WHEELS
- STURDY MATERIAL



PERSONAL DRY BOX

code: 415727

- LANYARD FOR TRANSPORTATION
- DRY SEAL FOR WATERTIGHT CLOSURE
- SLEEK DESIGN
- SMALL AND DURABLE



MAGNETIC SHAKER

code: 415772

- SPECIAL MAGNETIC SYSTEM
- TO PREVENT UNWANTED AND IRRITATING NOISE
- LIGHTWEIGHT AND EASY TO STORE
- EASY TO USE WITH JUST A SIMPLE DOWNWARD MOVEMENT



UNDERWATER SLATE

code: 415719

- BRIGHT WHITE WRITING SLATE
- COMPACT SIZE: 12X15 cm
- HOOK SYSTEM TO ATTACH TO YOUR BCD
- QUICK RELEASE BUCKLE
- STANDARD REPLACEABLE PENCIL WITH SILICONE TUBE



TANKS

code 10L Single Valve: **415078**

code 12L Single Valve: **415079**

code 15L Double Valve: **415080**

- SINGLE PIECE CONSTRUCTION IN STEEL ALLOY
- 3 SIZES 10L, 12L AND 15L
- MEETS DIRECTIVE 97/23CE REQUIREMENTS
- INT/DIN VALVE CONNECTION
- RUBBER BOOT
- OPTIONAL SECOND CONNECTION FOR 12L AND 10L SINGLE VALVE



10L

12L

15L

Single piece construction in steel alloy with chrome molybdenum 3CrMo4 (DIN 17200).

Code	415078	415079	415080
Volume	10 liters	12 liters	15 liters
Valve	single	single	double
Weight	13.5 kg / 29.6 lb	16.5 kg / 36.5 lb	20 kg / 44.1 lb
Height	67 cm / 26.4 in	61 cm / 24.0 in	71 cm / 28.0 in
Diameter	18 cm / 7.0 in	22 cm / 8.6 in	22 cm / 8.6 in
Operating pressure	232 bar		
Material	heat-treated steel		
Internal coating	phosphate coating and anti-corrosion treatment		
Black external coating	soft touch polyurethane coating		

TANK NETS

code 10L YL: **415749**

code 12L BL: **415731**

code 15L BK: **415730**

- HIGH QUALITY NYLON
- VARIOUS COLORS & SIZES
- 10L/YELLOW, 12L/BLUE AND 15L/BLACK



10L

12L

15L

VALVE 2ND CONNECTION

code: **45180732**

- INT/DIN VALVE CONNECTION
- OPTIONAL FOR 10 AND 12 LITER TANK VALVES



DIVER TOOLKIT

code: **415726**

- IDEAL FOR TROUBLE-SHOOTING ON DIVING EQUIPMENT
- 20 TOOLS INCLUDING SPANNERS, SCREWDRIVERS, PLIERS, ALLEN KEYS AND MORE
- HANDY SIZE ZIPPERED CASE
- EASY STORAGE



MULTI TOOLS

code: **415701 Multi Tools Pro**

code: **415703 Multi Tools Tech**

- TWO VERSIONS FOR ALL NEEDS
- TECH: VARIOUS SPANNERS AND SCREWDRIVERS
- PRO: VARIOUS SPANNERS AND ALLEN WRENCHES
- HIGH QUALITY STAINLESS STEEL WITH NICKEL COATING
- EASY TO USE
- EXCLUSIVE MARES DESIGN
- OVERMOLDED HANDLE WITH MARES LOGO



Multi Tools Pro

Multi Tools Tech

PROMO MATERIAL

POP TORCHES

NEW

code: 449667

- PLEXIGLAS DESK DISPLAY
- EOS RZ TORCH RANGE
- SIZE: APPROX 35 X 60 cm



POP AST

NEW

code: 449662

- CARDBOARD DESK DISPLAY
- SIZE: 22 X 30 cm



POP BUNGEE STRAP

NEW

code: 449664

- CARDBOARD DESK DISPLAY
- SIZE: 22 X 30 cm



FILLER BAG

code: 449936

- SIZE: APPROX 75X40X20 cm



POP BCD's

NEW

code: 449657

- CARDBOARD DISPLAY
- SUBJECT: PRESTIGE, PURE/BOLT, DRAGON/KAILA



POP BCD

NEW

code: 449663

- CARDBOARD DISPLAY
- SUBJECT: PRIME



CARPET

code: 449315

- SIZE: 90X60 cm



POP QUAD AIR

NEW

code: 449666

- CARDBOARD TOWER DISPLAY
- SIZE: APPROX 55 X 125 cm



POP EPIC 82X

NEW

code: 449665

- CARDBOARD TOWER DISPLAY
- SIZE: APPROX 55 X 125 cm

